

# STEEL FRAMES FOR EXPERTS

FROM THE MARKET LEADER!



# Design · Function · Efficiency

## STEEL FRAME SPECIALISTS SINCE 1967

Commended for outstanding design and produced with over 55 years of experience: Steel frames for doors and windows from the leading manufacturer BOS Best Of Steel. Our name stands for consistent customer orientation, reliability and punctuality as well as maximum flexibility. These values make BOS Best Of Steel the market leader in Germany and the leading address in many European countries.

Our quality promise:

As a system supplier and problem solver, we do everything we can to constantly improve our high level of quality in all areas. Each of our over 450 employees contributes significantly with their commitment and performance to our joint success – every day.



BOS Best Of Steel has been manufacturing frames since 1967



Quality



Environment



Safety



Energy



## KEY TO ABBREVIATIONS

AMB	= Overall width	LDH	= Clearance height
AMH	= Overall height	LDH effektiv	= Effective clearance height
BA	= Distance between hinges	LK	= Track case
BE	= Foundation bedding	MW	= Receiving opening
DH	= Handle height	OFF	= Top level of finished floor
FB	= Rebate width	RNB	= Nominal wall opening width
FMB	= Rebate measurement width	RNH	= Nominal wall opening height
FMH	= Rebate measurement height	RRB	= Structural wall opening width
FT	= Rebate depth	RRH	= Structural wall opening height
GT	= Total profile depth	TAB	= Overall door leaf width
LDB	= Clearance width	TAH	= Overall door leaf height
LDB effektiv	= Effective clearance width		

# Contents

<b>Profile versions</b>	
➤ Steel frames for active leaf doors	4
➤ Steel frames for sliding doors	5
<b>Steel frames</b>	
➤ Diversity of design	6
➤ Materials and surfaces	7
<b>Steel frames for active leaf doors</b>	
➤ Introduction	8
➤ DIN measurement table	9
➤ Planning of wall openings	10
➤ Backfilling of frames	11
➤ Steel frames for brick walls	12
➤ Steel frames for stud walls	13
➤ Steel frames for almost all wall types	14
➤ Steel frames between two walls	16
➤ Element frames	18
➤ Transom bar profiles   Glazing beads for element frames	19
➤ Attachment parts   hinges   hinge pockets	20
➤ Distances between hinges according to DIN 18101	21
➤ Add-on components for lock area	22
➤ Wall connections	23
<b>Steel frames for sliding doors</b>	
➤ Introduction	24
➤ LineaOutside for brick walls	26
➤ LineaOutside for stud walls	27
➤ LineaCompact for brick   stud walls	28
➤ LineaSet   LineaSet One for stud walls	29
➤ LineaECON5	30
Steel frame measuring aid for active leaf doors	31
Architect Consulting Service	32

## SUSTAINABLE BUILDING

BOS Best Of Steel combines frame design with sustainable building. BOS steel frames in various designs that have been evaluated according to LEED and DGNB criteria can be found on the service platform [www.building-material-scout.com](http://www.building-material-scout.com).



Subject to technical change. The illustrations are not for static information.

# Steel frames for active leaf doors

## Profile versions

Wrap around frame



Sino frame

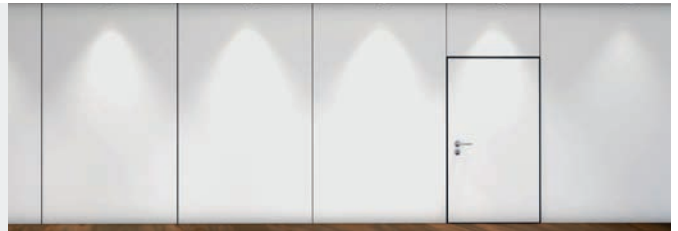
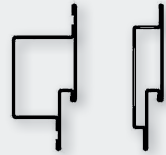

Shadow groove frame

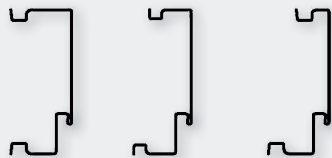

SafetyDesign frame

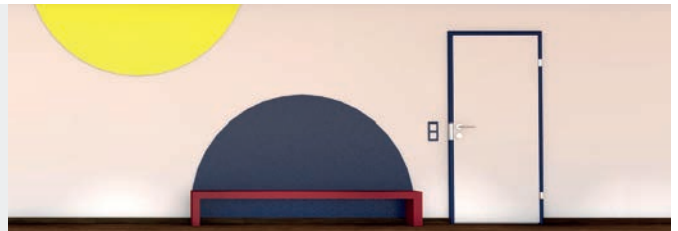

Planar soffit frame

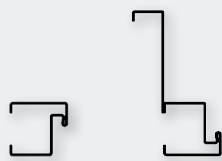

Your idea ...

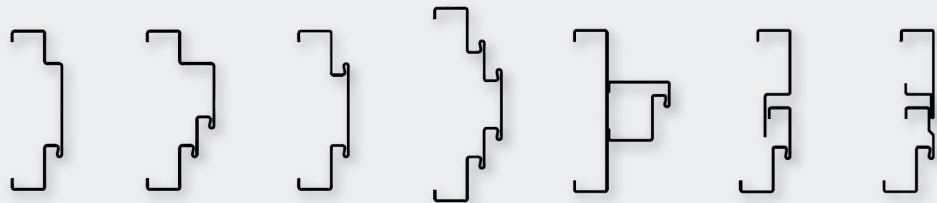

Profile examples

- Steel frames in various designs
- For brick or stud walls
- Other versions available

# Steel frames for sliding doors

## Profile versions

LineaOutside

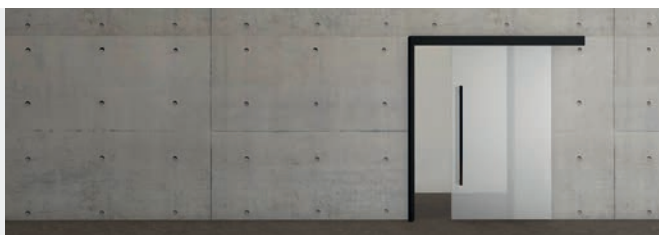

LineaCompact Sino

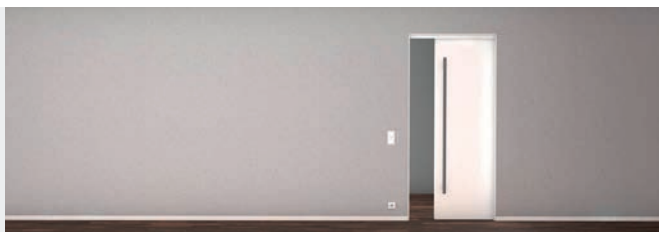
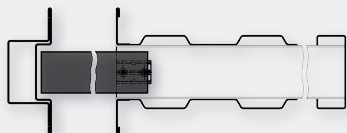

LineaCompact with shadow groove

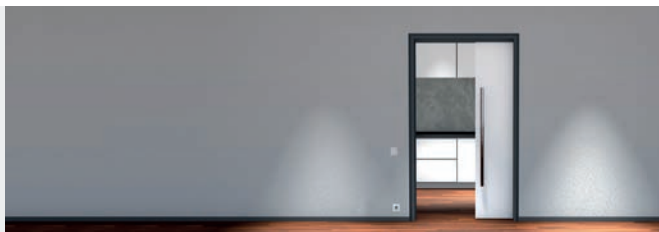
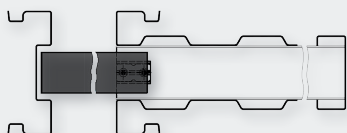

LineaSet

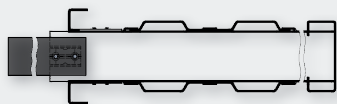

LineaLevel

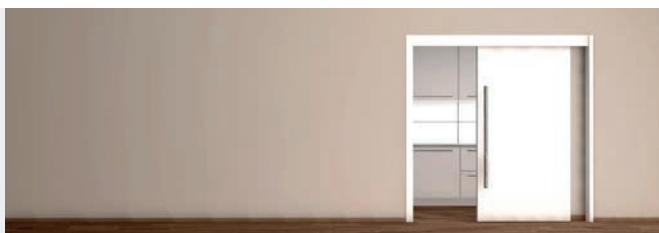
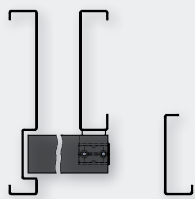

Your design ...



### Profile examples

- Steel frames in various designs
- For brick or stud walls
- Other versions available

# Steel frames

## Diversity of design

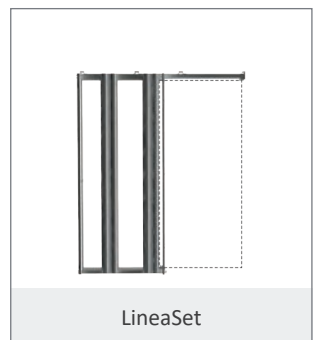
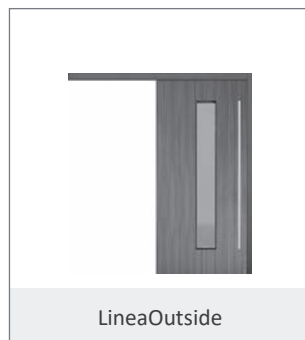
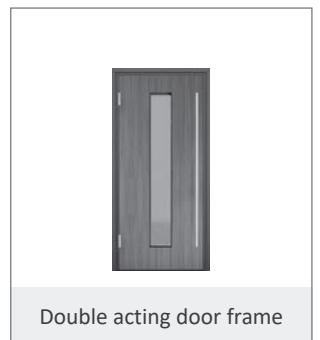
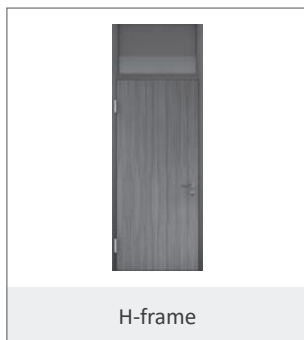
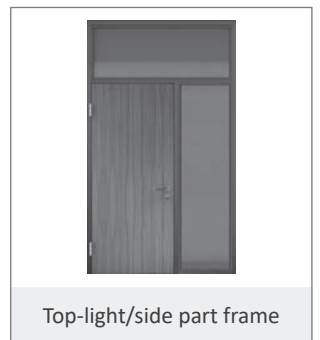
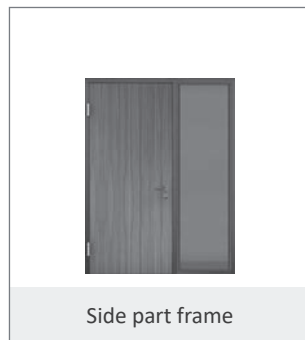
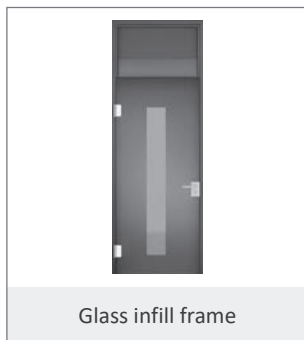
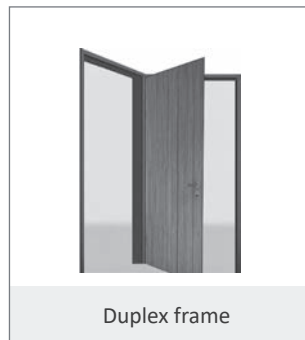
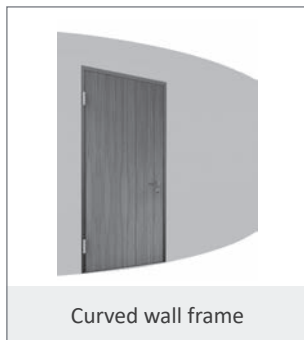
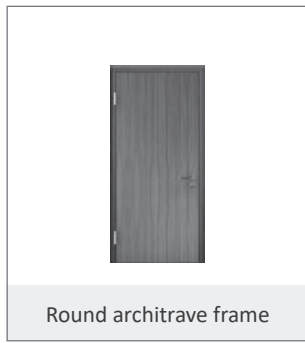

# Steel frames

## Materials and surfaces

### STEEL

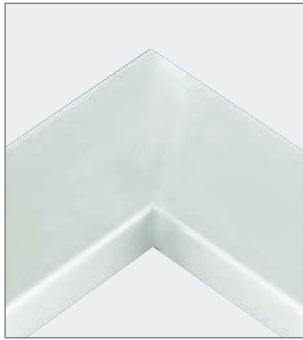

#### Aqua-Air primer

- ✔ Water-based
- ✔ Very environmentally-friendly
- ✔ Solvent proportion less than 3%. Meets the VOC Directive.



#### Powder coating – silk gloss finish



#### Powder coating – textured finish

### STAINLESS STEEL

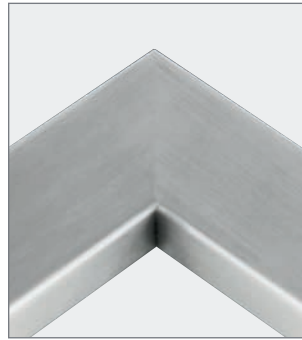

Premium quality mitre connection in the architrave and backbend continuously welded, brushed and polished



Top P quality visible mitre joint



BOS frames can be given a powder coating finish in all RAL colours as an option. Special colours are available on request.



Many building projects where Aqua-Air primer has been used have already received an Environmental Award from the DGNB (German Sustainable Building Council).

# Steel frames for active leaf doors

The character of a room is shaped right from the entry area – steel frames are an indispensable part of modern interior design. A steel frame is a frame which provides the connection between wall and door, being produced to exactly fit the wall opening and the door. The frames can be supplied in one part or as a two part split frame, for installation together with the wall or afterwards.

The areas of application for frames are varied and comprehensive. You can find well thought-out solutions for different wall types here, which represent just a selection out of our programme.

Steel frames for brick walls	12
Steel frames for stud walls	13
Steel frames for almost all wall types	14
Steel frames between 2 walls	16
Element frames	18





# Steel frames for active leaf doors

## DIN measurement table

(All measurements given are in mm)

Overall door leaf measurement rebated doors DIN 18101  
Overall door leaf measurement flush doors DIN 18101

RRB	RRH	RNB	RNH	FMB	FMH	Single rebate		Double rebate		Rebated		Flush	
						LDB	LDH	LDB	LDH				
625	1875	635	1880	591	1858	561	1843	531	1828	610	1860	584	1847
750	1875	760	1880	716	1858	686	1843	656	1828	735	1860	709	1847
875	1875	885	1880	841	1858	811	1843	781	1828	860	1860	834	1847
1000	1875	1010	1880	966	1858	936	1843	906	1828	985	1860	959	1847
1125	1875	1135	1880	1091	1858	1061	1843	1031	1828	1110	1860	1084	1847
1250	1875	1260	1880	1216	1858	1186	1843	1156	1828	1235	1860	1209	1847
625	<b>2000</b>	635	2005	591	1983	561	1968	531	1953	610	1985	584	1972
750	<b>2000</b>	760	2005	716	1983	686	1968	656	1953	735	1985	709	1972
875	<b>2000</b>	885	2005	841	1983	811	1968	781	1953	860	1985	834	1972
1000	<b>2000</b>	1010	2005	966	1983	936	1968	906	1953	985	1985	959	1972
1125	<b>2000</b>	1135	2005	1091	1983	1061	1968	1031	1953	1110	1985	1084	1972
1250	<b>2000</b>	1260	2005	1216	1983	1186	1968	1156	1953	1235	1985	1209	1972
625	<b>2125</b>	635	2130	591	2108	561	2093	531	2078	610	2110	584	2097
750	<b>2125</b>	760	2130	716	2108	686	2093	656	2078	735	2110	709	2097
875	<b>2125</b>	885	2130	841	2108	811	2093	781	2078	860	2110	834	2097
1000	<b>2125</b>	1010	2130	966	2108	936	2093	906	2078	985	2110	959	2097
1125	<b>2125</b>	1135	2130	1091	2108	1061	2093	1031	2078	1110	2110	1084	2097
1250	<b>2125</b>	1260	2130	1216	2108	1186	2093	1156	2078	1235	2110	1209	2097
625	2250	635	2255	591	2233	561	2218	531	2203	610	2235	584	2222
750	2250	760	2255	716	2233	686	2218	656	2203	735	2235	709	2222
875	2250	885	2255	841	2233	811	2218	781	2203	860	2235	834	2222
1000	2250	1010	2255	966	2233	936	2218	906	2203	985	2235	959	2222
1125	2250	1135	2255	1091	2233	1061	2218	1031	2203	1110	2235	1084	2222
1250	2250	1260	2255	1216	2233	1186	2218	1156	2203	1235	2235	1209	2222

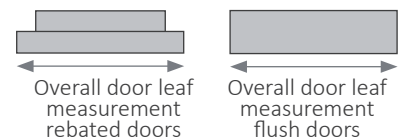

Non-standard frame similar to DIN 18111

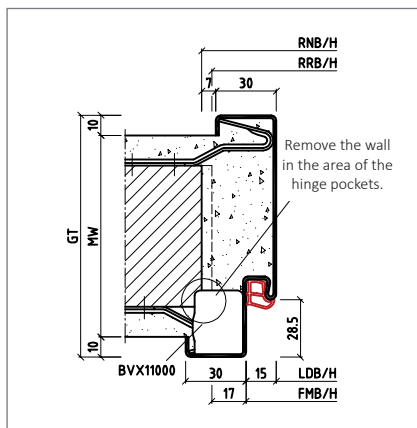

15ZBud, 2 part split

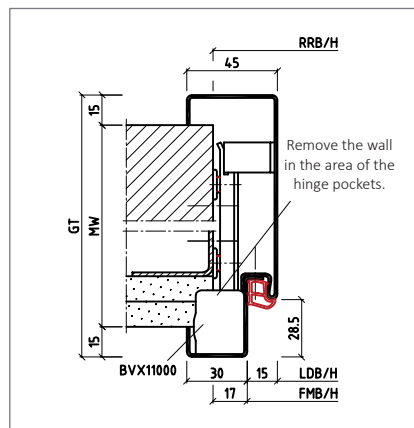

The structural wall opening measurement is the ideal measurement for installing the 15ZBud.

**Key:**

- RRB/H: Structural wall opening width/height
- RNB/H: Nominal wall opening width/height
- FMB/H: Rebate measurement width/height
- LDB/H: Clearance width/height
- GT: Total profile depth
- MW: Receiving opening

For flush frames the wall needs to be removed in the area of the mortar case as well.

# Steel frames for active leaf doors

## Planning of wall openings

The rules for planning and producing door openings in walls are described in DIN 18100. The measurements are derived from the „Dimensional coordination in construction building“ according to DIN 4172.

The designation of a wall opening according to the basic dimensions of e.g. 875mm width and 2000mm height means a wall opening of 875 x 2000 according to DIN 18100 (see page 9: structural wall opening width RRB and structural wall opening height RRH).

### Permissible deviations:

- + 10mm for the width
- + 10mm for the height
- 5mm for the height

### The following applies within the scope of the standard:

Nominal measurement of the wall opening width = basic dimensions + 10mm

Nominal measurement of the wall opening height = basic dimensions + 5mm

Minimum permissible measurement = basic dimension  
 (nominal measurement - 10mm for the wall opening width)  
 (nominal measurement - 5mm for the wall opening height)

Maximum permissible measurement = basic dimension + 20mm for the wall opening width  
 (nominal measurement + 10mm)  
 basic dimension + 15mm for the wall opening height  
 (nominal measurement + 10mm)

### Plan and vertical section example (nominal measurement of opening 885 x 2005mm)

Plan:

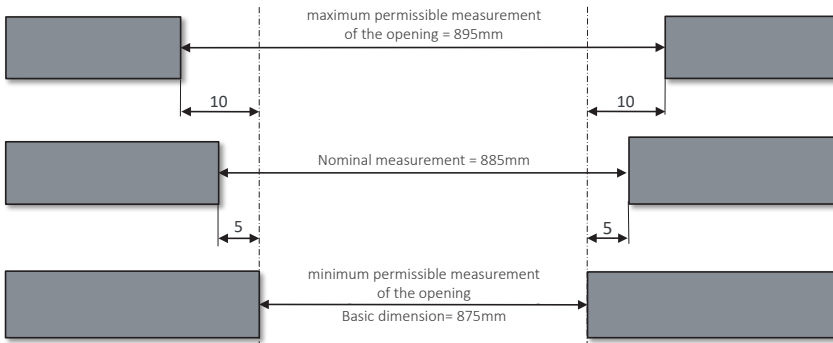

Vertical section:

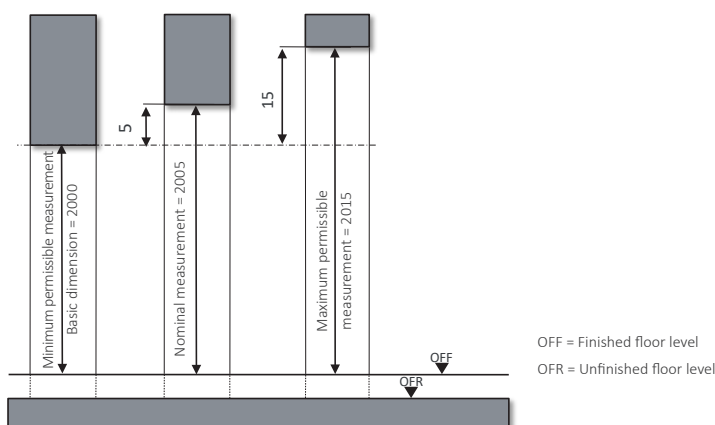

### Derivation of the nominal measurements from the construction dimensions:

As the nominal measurements refer to the finished floor level for the height, it is necessary for metre marks to be positioned on the walls on site (marking of the nominal position of the finished floor level plus 1000mm).

# Steel frames for active leaf doors

## Backfilling of frames

### DIN 18111 PART 3:

DIN 18111 Part 3 specifies the installation of steel frames. The basis for the installation and backfilling of frames is the ttz guidelines for installation of steel frames, published by the German Industrial Association for doors and frames. Information on the use of backfilling materials is generally to be specified by the client.

### Backfilling of one part frames for brick walls

According to DIN 18111-3, Sections 5.2.2 and following:

„The cavity between the steel frame and the wall must be completely filled with backfill materials. Partial backfilling (but at least 50%) is to be agreed between the client and the contractor. In the case of a partial backfilling, the backfill materials are to be applied where the highest loads occur, e.g. in the hinge and lock area. The type of backfill material is to be determined by the client. Suitable backfill materials are:

➤ Mortar in accordance with DIN EN 1996-1-1, DIN EN 1996-1-1/NA, DIN EN 1996-2, DIN EN 1996-2/NA, DIN EN 1996-3, DIN EN 1996-3/NA earth-moist processed or frame grouting mortar. Note: Due to the residual stress of the cold-formed sheet metal and the shrinkage process of the mortar, a permissible separation between the sheet metal and the backfill material can occur. No installation defect can be derived from this.

➤ Installation foams (preferably two-component expansion adhesives)  
The backfill materials must not form compounds with the other materials that lead to corrosion or chemical reactions. The mortar must form a material bond with the wall, however, not to the steel frame. Installation foams must form a material bond with the wall and with the frame. The hardened installation foams must be form-stable, i.e. they must neither shrink nor expand. Installation foams (two-component expansion adhesives), low-viscosity grouting mortar and low-viscosity gypsum dry mortar require an additional sealing of the hinge sub-structures and mortar protection cases. For doors with special requirements, the backfilling specifications of the door leaf manufacturer must be followed.“

### Backfilling of frames in stud walls and 2 part split frames

According to DIN 18111-3, Sections 5.3.2 and 5.4.2:

„The backfilling of frames in stud walls and 2 part split frames for doors without special requirements is generally not necessary. For doors with special requirements, the backfilling specifications of the door leaf manufacturer must be followed.“

### TTZ INSTALLATION GUIDELINES:

„After agreement between the client and the contractor, a partial backfilling of at least 50% of the cavity between the wall and the steel frame can take place. In this case, installation foams are to be applied where the highest loads occur, e.g. in the hinge and lock area.“

Notes:

- Installation foams and low-viscosity backfill materials require an additional sealing of the hinge pockets and lock cases.
- For doors with special requirements, the backfill specifications of the door leaf manufacturer must be followed.
- For on-site foaming, slotted holes in the sealing groove and mortar-tight hinge pockets can be selected.

# Steel frames for active leaf doors for brick walls



For flush frames the wall needs to be removed in the area of the mortar case as well.

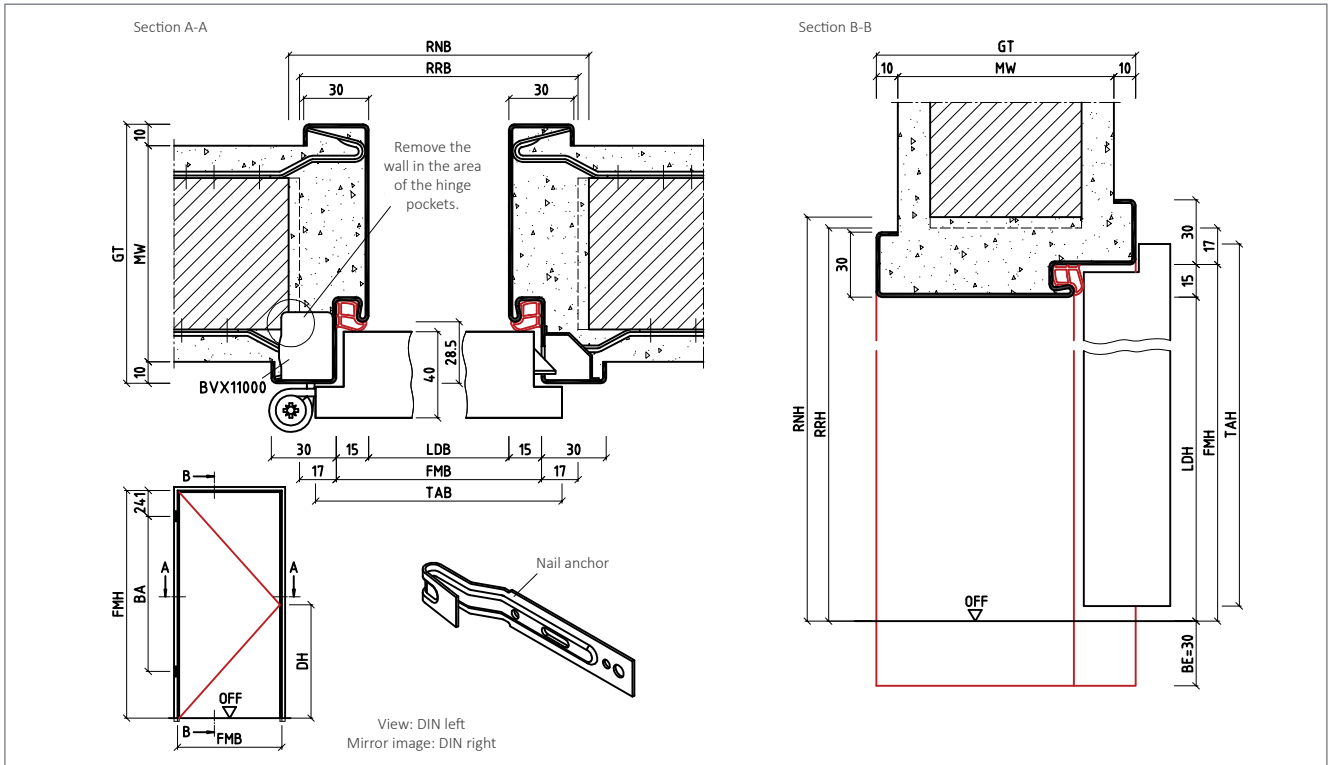

Uud

- Wrap around frame (1 part)
- For brick walls
- Illustration with nail anchor and hinge pocket BVX11000

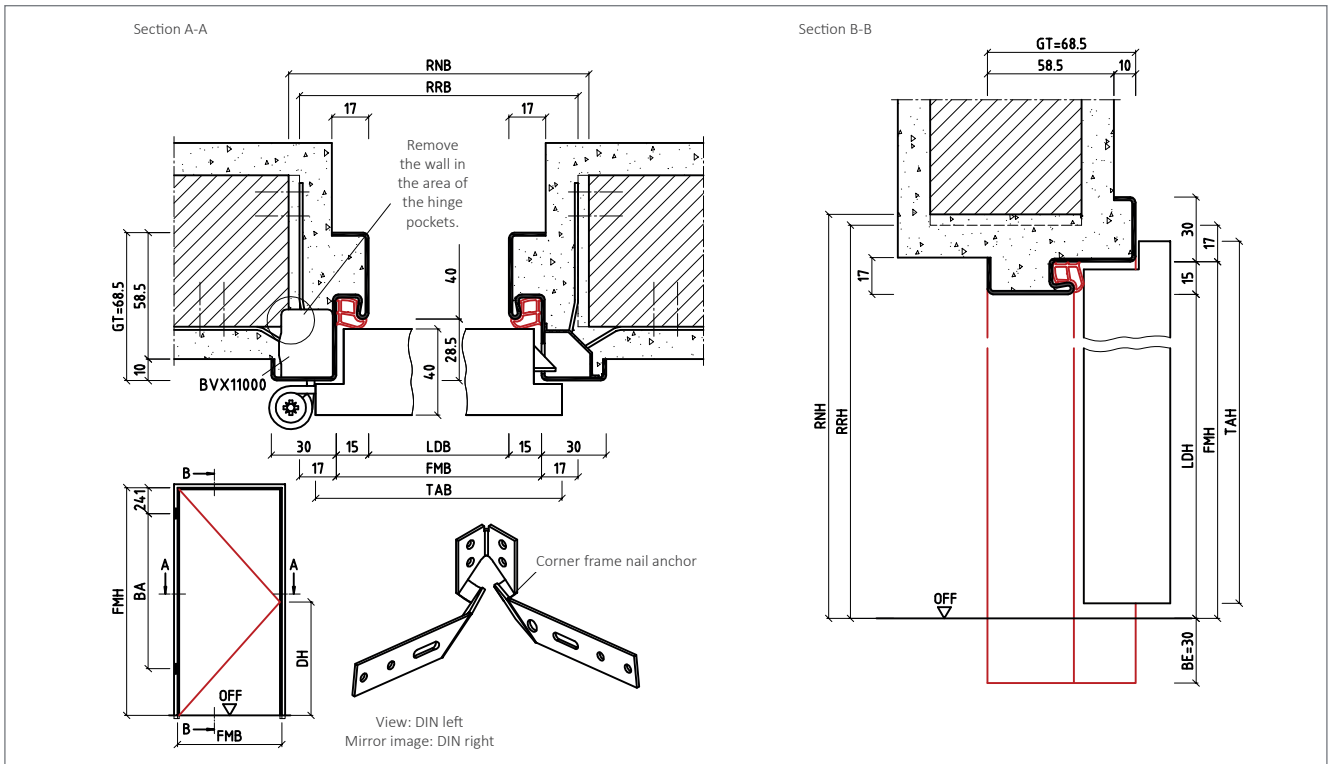

Eud

- Corner frame (1 part)
- For brick walls
- Illustration with corner frame nail anchor and hinge pocket BVX11000

# Steel frames for active leaf doors for stud walls

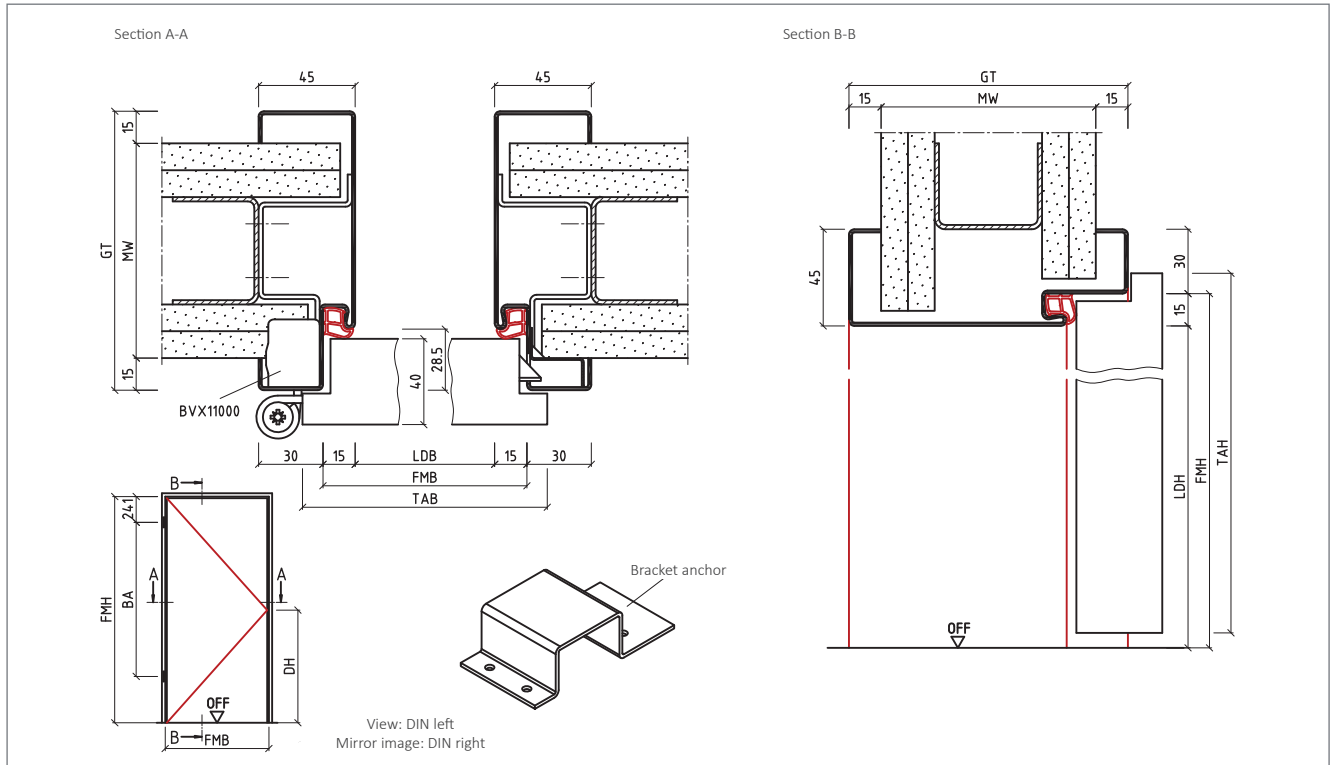

## Bud

- Wrap around frame as block profile (1 part) for installation together with the wall
- For stud walls
- Illustration with bracket anchor and hinge pocket BVX11000

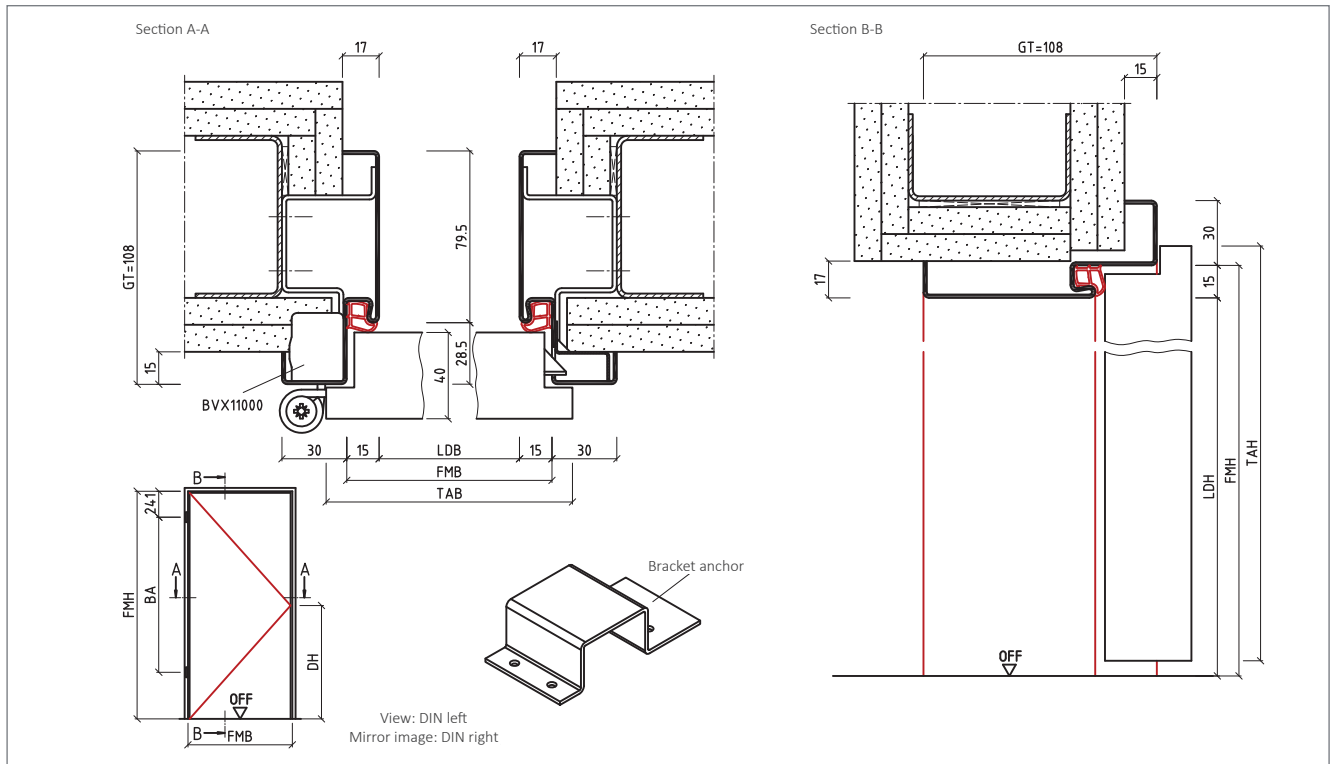

## Eud

- Corner frame (1 part) for installation together with the wall
- For stud walls
- Illustration with bracket anchor and hinge pocket BVX11000

# Steel frames for active leaf doors for almost all wall types

For flush frames the wall needs to be removed in the area of the mortar case as well.

## OUR RECOMMENDATIONS

### 1 Installation as wrap around frame

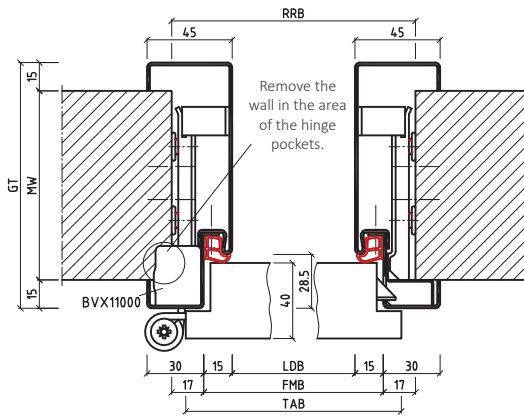

**Our recommendation:**  
Choose an architrave width of at least 35/50mm, in order to cover any possible chasing out of the wall.

### 2 Installation as flush block frame

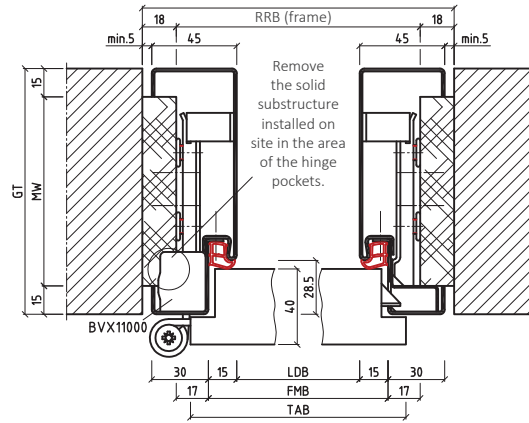

**Attention:**  
For DIN door leaf increase the RRM of the wall (RRB +36 mm and RRH +18 mm)

### 15ZBud

- Wrap around frame as block profile (2 part split) for installation after wall completion
- For fairfaced brickwork
- Easy mortar-free installation with levelling anchor
- Illustration with levelling anchor, hinge pocket BVX11000 and small mortar protection case

## FURTHER DESIGNS

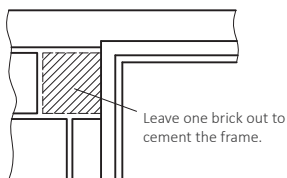
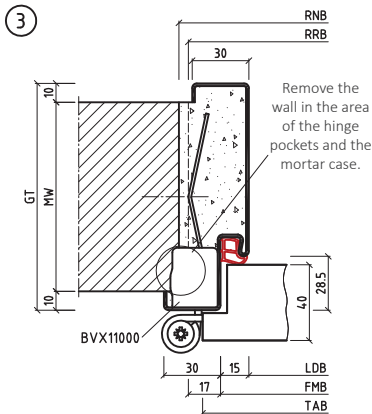

We recommend a wider architrave to cover the structural wall opening safely.

**Uud**  
Wrap around frame (1 part)  
For fairfaced brickwork

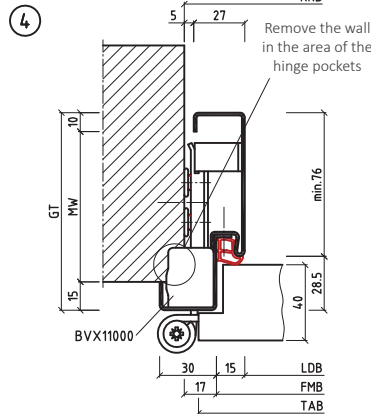

We recommend a wider architrave to cover the structural wall opening safely.

**15ZUud**  
Corner frame (2 part split)  
For fairfaced brickwork/exposed concrete

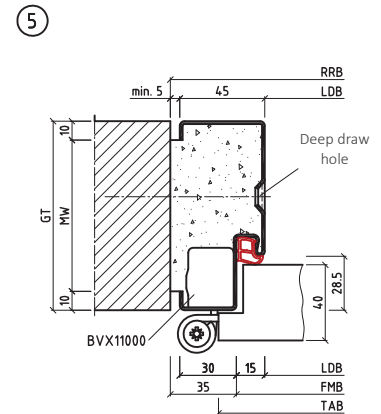

**Attention:**  
For DIN door leaf increase the RRM of the wall (RRB +36 mm and RRH +18 mm)

**Bud**  
Block frame (1 part)  
For almost all wall types

# Steel frames for active leaf doors for almost all wall types

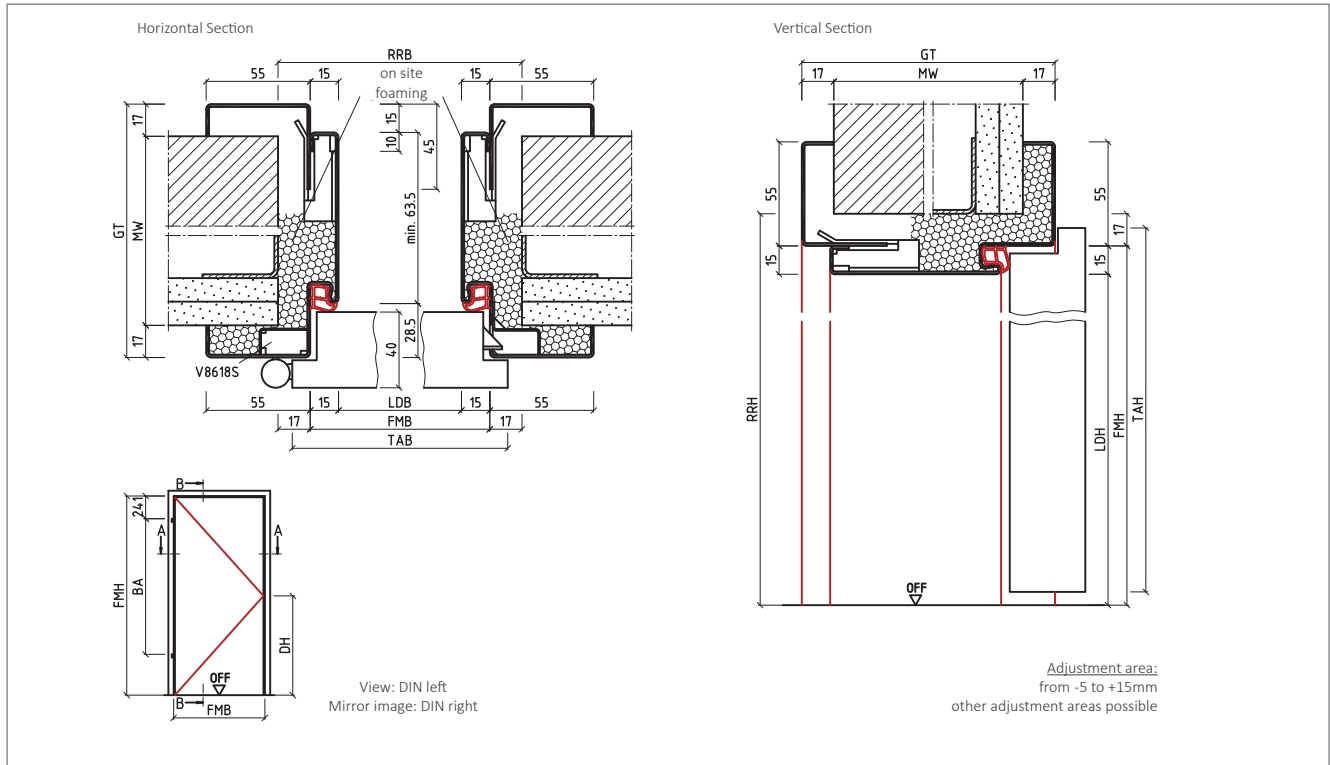

wjAud  
EasyFix

- frame for installation after wall completion
- easy installation through foaming
- installation with hinge pocket V8618 S (foam impervious)

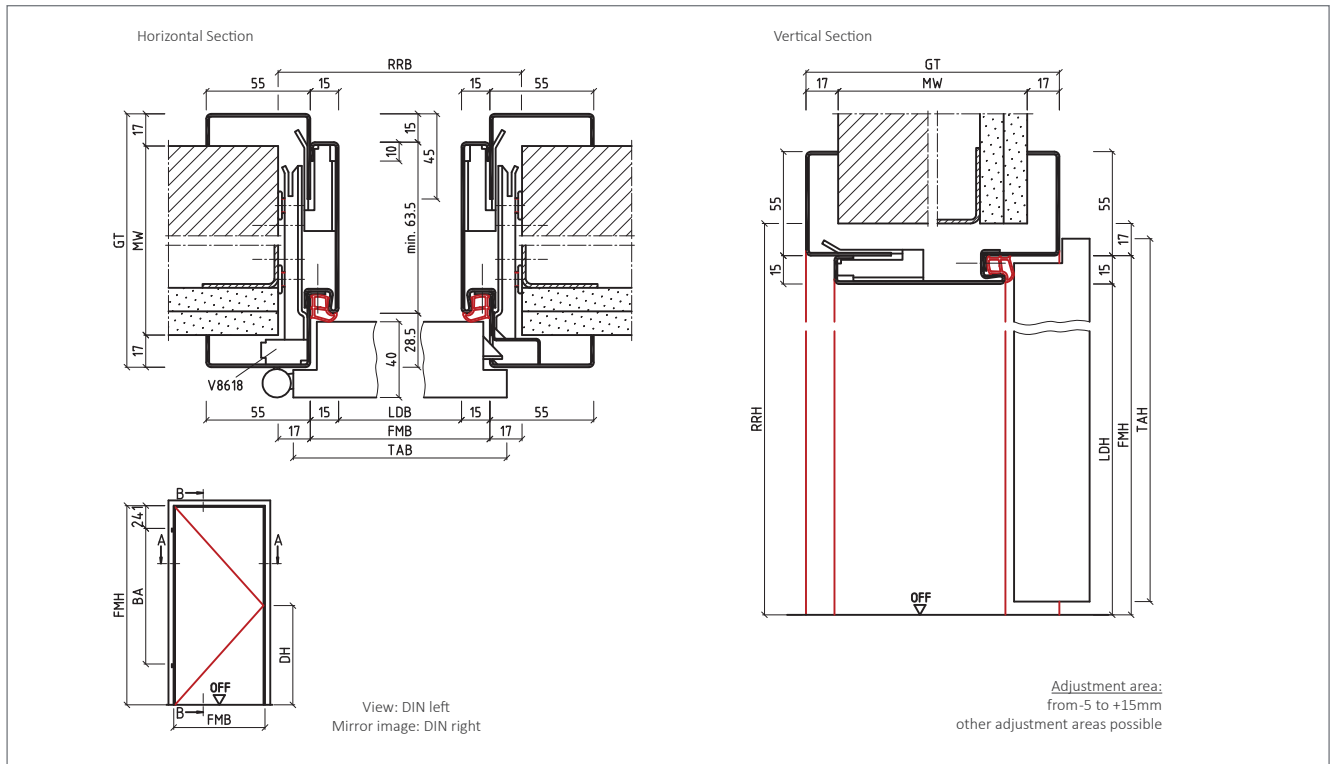

15ZwjAud  
SolidFix

- solid frame for installation after wall completion
- easy mortar-free installation with levelling anchor
- illustration with levelling anchor and hinge pocket V8618

# Steel frames for active leaf doors between two walls

For flush frames the wall needs to be removed in the area of the mortar case as well.

OUR RECOMMENDATION

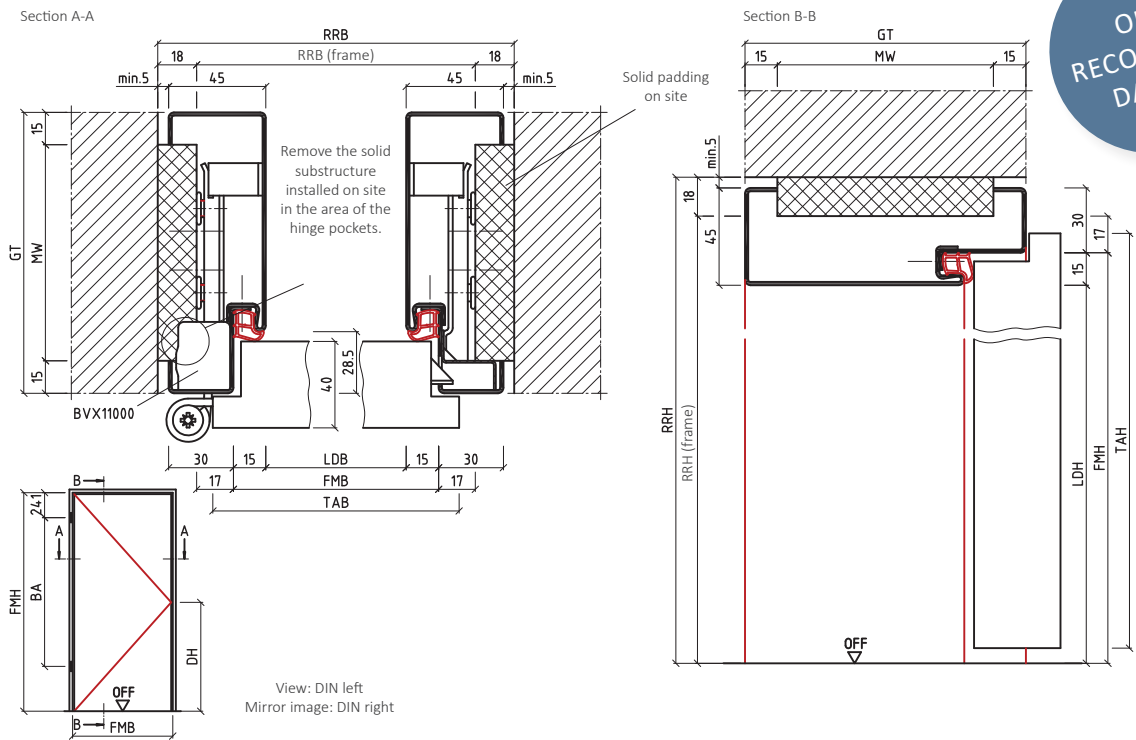

## 15ZBud

- Block frame (2 part split)
- Between two walls
- Easy mortar-free installation with levelling anchor
- Illustration with levelling anchor and hinge pocket BVX11000

### ADVANTAGES OF THE 2 PART SPLIT STEEL FRAME:

- Subsequent installation together with the door leaf, therefore tendering is possible in one trade
- Suitable for almost all wall types
- Installation in narrow walls possible
- Significantly less risk of damage to the powder coating
- Optimal solution for exposed masonry and exposed concrete as well as for installation between two walls

### INSTALLATION PROCEDURE FOR THE 2 PART SPLIT FRAME 15ZBud

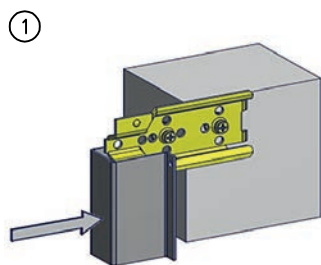

1 Push the front part into the wall opening.

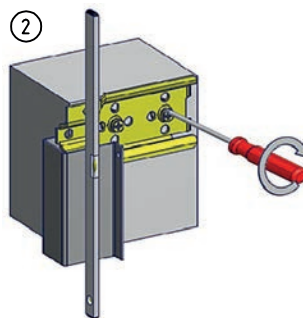

2 Align the front part using the levelling screws and then join to the wall.

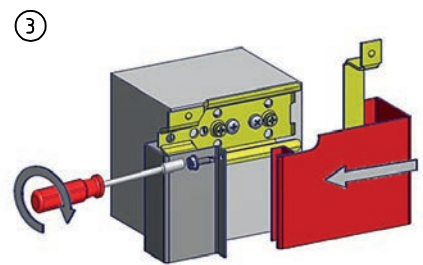

3 Push the back part into position and screw the two parts together in the seal groove.

## Levelling anchor

- BOS levelling anchor with guiding anchor
- Particularly installation-friendly
- Distance to the wall can easily be adjusted using a screwdriver



# Steel frames for active leaf doors between two walls

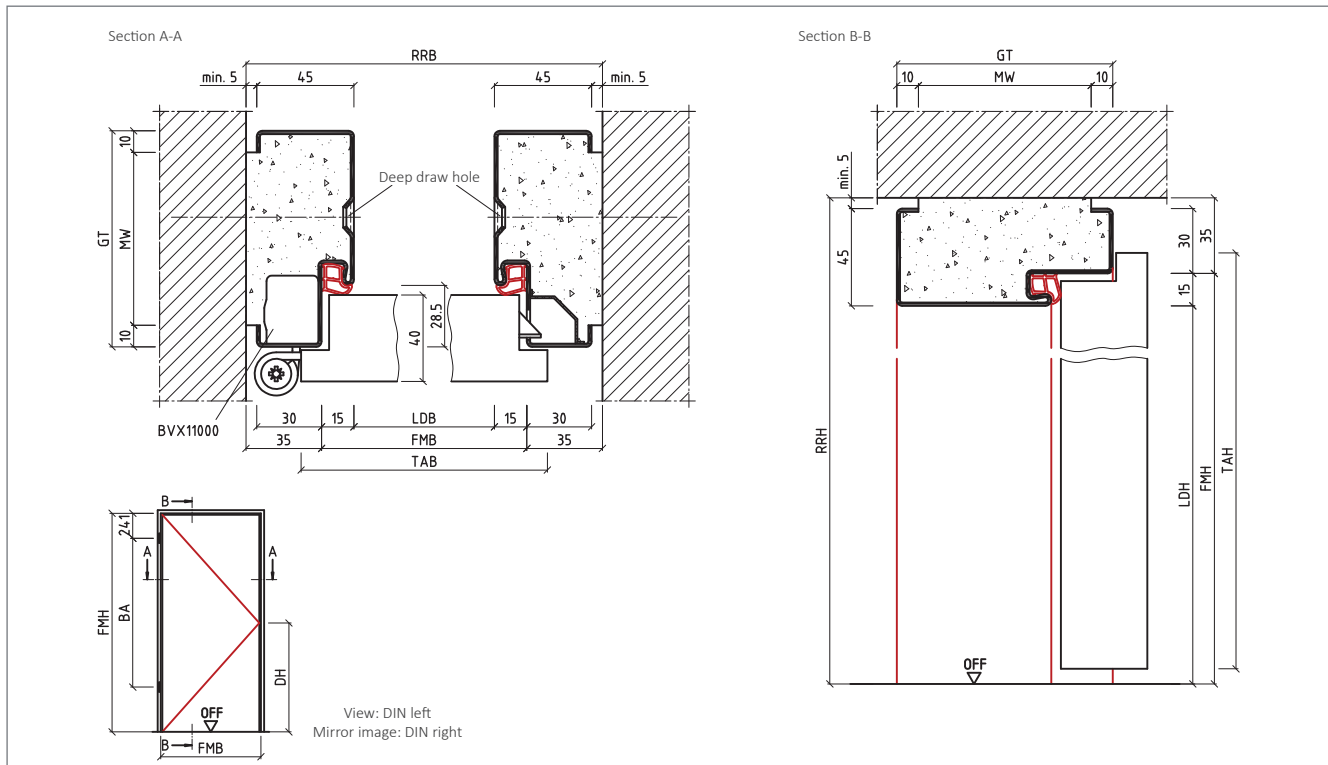

Bud

- Block frame (1 part)
- Between two walls
- Illustration with deep draw hole and hinge pocket BVX11000

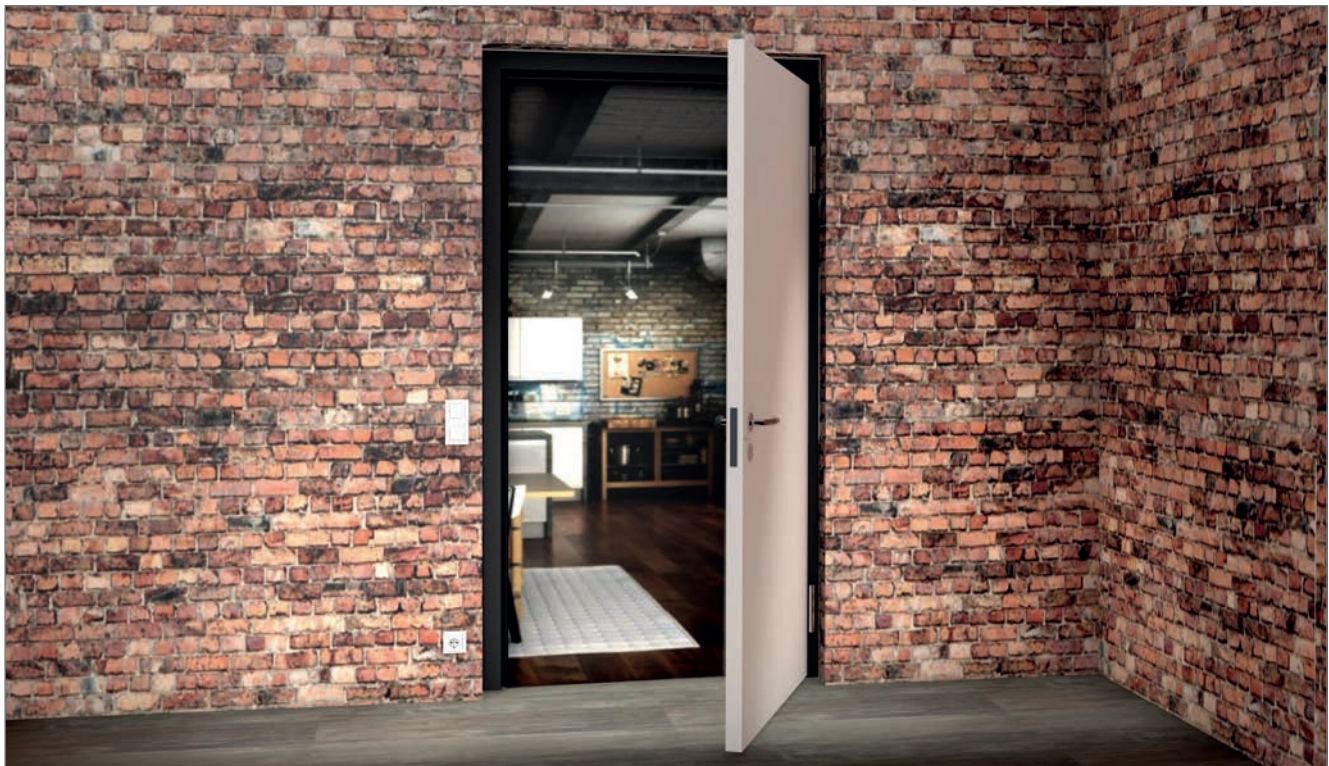

Bud

- Block frame
- Between two walls

# Steel frames for active leaf doors

## Element frames

Element frames provide pleasant light conditions and greater transparency within buildings. As well as top-light, side part and top-light/side part frames, BOS Best Of Steel offers steel frames for timber and glass infills.

The frame profiles can be designed individually. For example shadow groove and Sino frames can be supplied as elements and a side part frame can be combined with a timber infill.



# Steel frames for active leaf doors

## Transom bar profiles | Glazing beads for element frames

BOS Best Of Steel offers a wide choice of transom bar profiles and glazing beads. Here you can find well thought-out solutions for every requirement and design preference, which represent just a selection out of our programme.

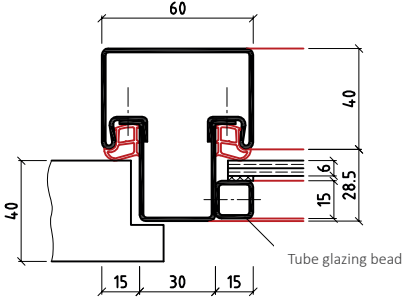
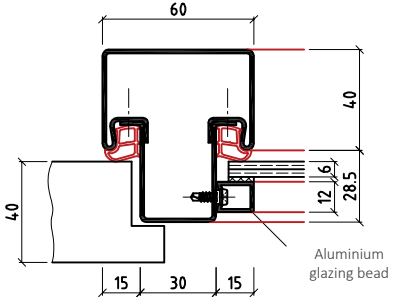
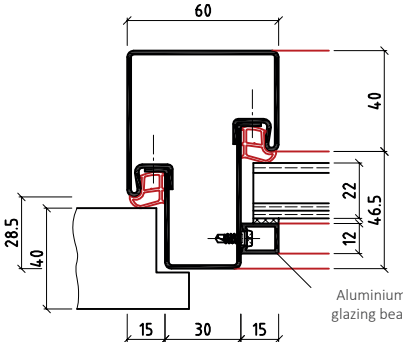
TRANSM BAR PROFILES FOR ELEMENT FRAMES		
<p>① OUR RECOMMENDATION</p>  <p>Tube glazing bead</p>	<p>②</p>  <p>Aluminium glazing bead</p>	<p>③</p>  <p>Aluminium glazing bead</p> <p><u>Advantage:</u> This transom bar allows for a uniform appearance, independent of the glass thickness.</p>
<p>KEud</p> <ul style="list-style-type: none"> <li>· Transom bar profile</li> <li>· Horizontal or vertical</li> <li>· Other versions possible</li> </ul>	<p>KEud</p> <ul style="list-style-type: none"> <li>· Standard transom bar profile</li> <li>· Horizontal or vertical</li> <li>· Other versions possible</li> </ul>	<p>QKEusd</p> <ul style="list-style-type: none"> <li>· Transom bar profile</li> <li>· Horizontal or vertical</li> <li>· Other versions possible</li> </ul>

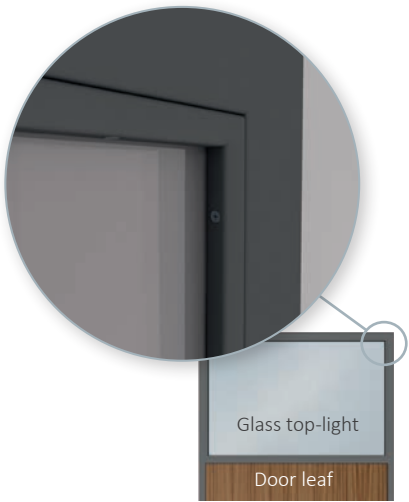
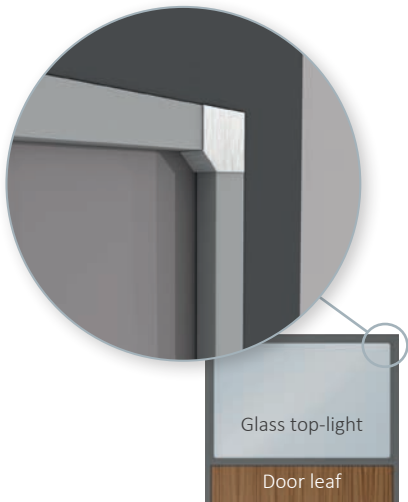
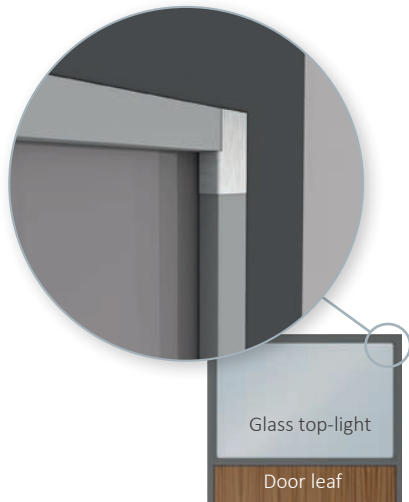
GLAZING BEADS FOR ELEMENT FRAMES		
<p>① OUR RECOMMENDATION</p>  <p>Glass top-light</p> <p>Door leaf</p>	<p>②</p>  <p>Glass top-light</p> <p>Door leaf</p>	<p>③</p>  <p>Glass top-light</p> <p>Door leaf</p>
<p>Tube glazing beads welded as frame</p>	<p>Aluminium glazing beads with glazing bead cover GL45 (standard)</p>	<p>Aluminium glazing beads with glazing bead cover GL90</p>

# Steel frames for active leaf doors

## Attachment parts | hinges | hinge pockets





The following attachment parts are supplied by BOS (mounted or separate):

- Hinge pockets
- BOS stainless steel striking plates
- Stainless steel bolt and latch hole reinforcements
- Electric door opener 118 with striking plate
- Latch adjustments
- Escape door opener
- Magnetic contacts
- Potential equalisation
- Bolt switch contacts

Provisions are made by BOS for the following mounting parts and accessories:

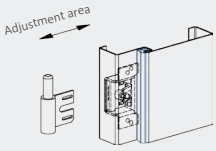
- Blocking devices
- Bolt switch contacts
- Cable transition
- Door closers (OTS, ITS, BTS)
- Door gap security
- Electric door openers
- Escape door opener
- Hinge side safeguards
- Magnetic contacts
- Multiple locks
- Power transmitters
- Striking plates

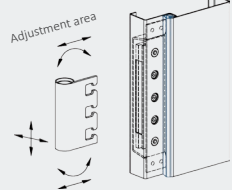
Do you have further requirements? Please contact us.

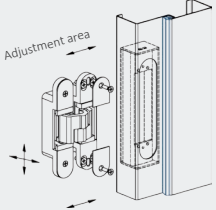
Hinge	Hinge pocket	Wall type	For rebated doors	For flush doors	
 <p>Hinge with 2 adjustment areas</p>		V8618	Stud wall	✓	✓
		BTV10200	Stud wall Brick wall	✓ ✓	✓ ✓
 <p>VX hinge with 3D adjustment</p>	<p>Our recommendation:</p> 	BVX11000	Stud wall Brick wall	✓ ✓	✓ ✓
 <p>Concealed hinge with 3D adjustment</p>		Tectus	Stud wall Brick wall	X X	✓ ✓
		Pivota	Stud wall Brick wall	X X	✓ ✓

BOS supplies the provision for these hinges.

# Steel frames for active leaf doors

## Distances between hinges according to DIN 18101

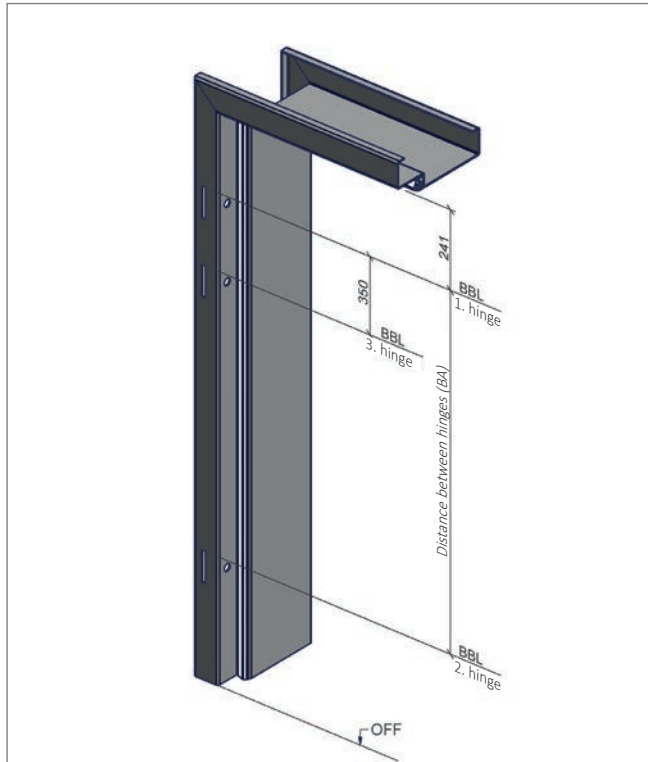

Hinge positions · Hinge pockets V8618 and BTV10200  
· Illustration: 3 hinge pockets

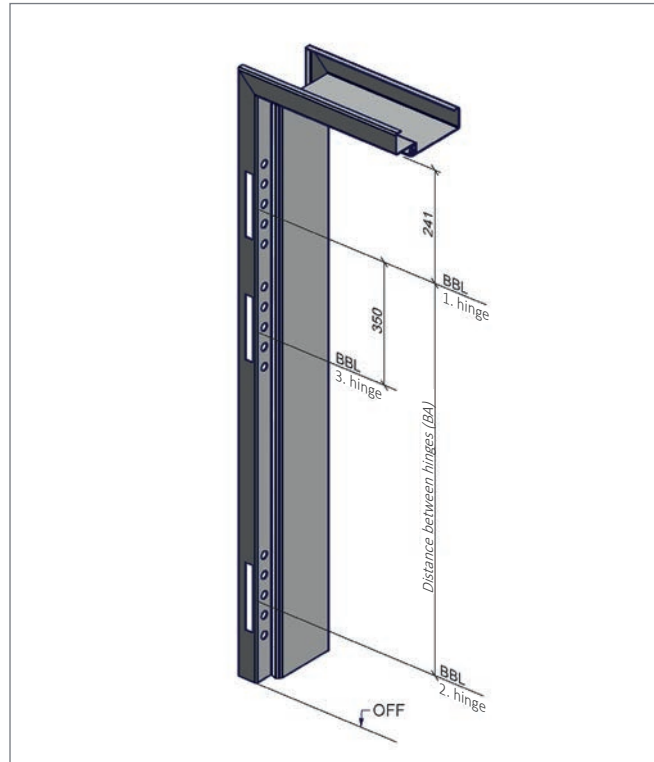

Hinge positions · Hinge pockets BVX11000  
· Illustration: 3 hinge pockets



Hinge positions · Hinge pockets V8618 and BTV10200  
· Illustration: 2 hinge pockets

Rebate measurement height (FMH)	Distance between hinges (BA)
in mm	in mm
1546 - 1670	1060
1671 - 1795	1185
1796 - 1920	1310
1921 - 2170	1435
2171 - 2295	1685
2296 - 2420	1810
2421 - 2545	1935
2546 - 2670	2060
2671 - 2795	2185

Distance between hinges according to DIN 18101. Other distances between hinges (BA) and hinge positions (BBL) are possible.

# Steel frames for active leaf doors

## Add-on components for the lock area

A door frame is only as sturdy as its striking plate. Striking plates reinforce the recesses which accommodate the latch and bolt.



rebated



flush

### Latch adjustment

With the BOS latch adjustment the contact pressure from the door to the seal can be easily adjusted. Any later difficulties of movement when using the door handle which could possibly arise can also be relieved through simple adjustment.

Your advantages:

- No filing
- Latch cut-out protection, tearing out is prevented to the greatest extent
- Subsequent tuning to adjust the contact pressure is possible



rebated



flush

### Stainless steel striking plate Protect

The stainless steel striking plate Protect is set into the frame instead of the latch/bolt cut-out.

Your advantages:

- No elaborate repainting of the latch entry
- Latch/bolt cut-out protection, a tearing out is prevented to the greatest possible extent
- Increases the life-span of the frame and offers investment security



rebated



flush

### Stainless steel striking plate Protect & Clean for higher hygienic demands

The stainless steel striking plate Protect & Clean is set into the frame instead of the latch/bolt cut-out. Also available with latch adjustment (for flush doors).

Your advantages:

- Hygienic, as the openings for the latch and bolt are closed from behind
- No elaborate repainting of the latch entry
- Latch/bolt cut-out protection, a tearing out is prevented to the greatest possible extent
- Increases the life-span of the frame and offers investment security

Recommended for  
hospitals



rebated



flush

### Stainless steel striking plate Protect with latch adjustment

The stainless steel striking plate Protect is set into the frame instead of the latch/bolt cut-out.

The latch adjustment allows the closing level to be ideally positioned and for the contact pressure to be regulated.

Your advantages:

- No filing
- Subsequent tuning to adjust the contact pressure is possible
- No elaborate repainting of the latch entry
- Latch/bolt cut-out protection, a tearing out is prevented to the greatest possible extent
- Increases the life-span of the frame and offers investment security

Recommended for  
residential and care homes

# Steel frames for active leaf doors

## Wall connections

When using wall tiles there are various solutions:



**Wrap around frame with backband**

If the tiles are laid on the wall, frames can be supplied with a wider backband, so that the tiles finish flush with the frame. Please contact us.



**Flush Planar soffit frame**

If flush frames are used, the wall tiles can be set into the wall to achieve a completely flush appearance.

When using a skirting board there are various solutions:

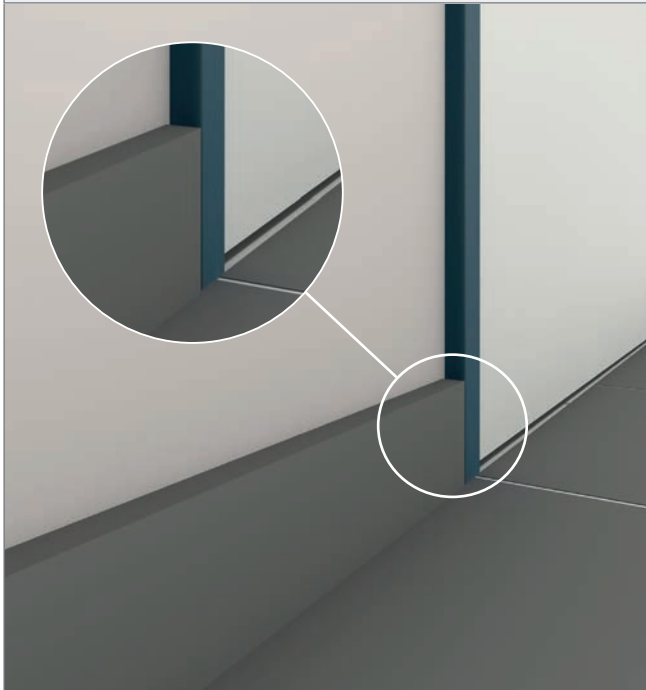

**Wrap around frame with backband**

If the skirting is placed on the wall, frames can be supplied with a wider backband, so that the skirting finishes flush with the frame.

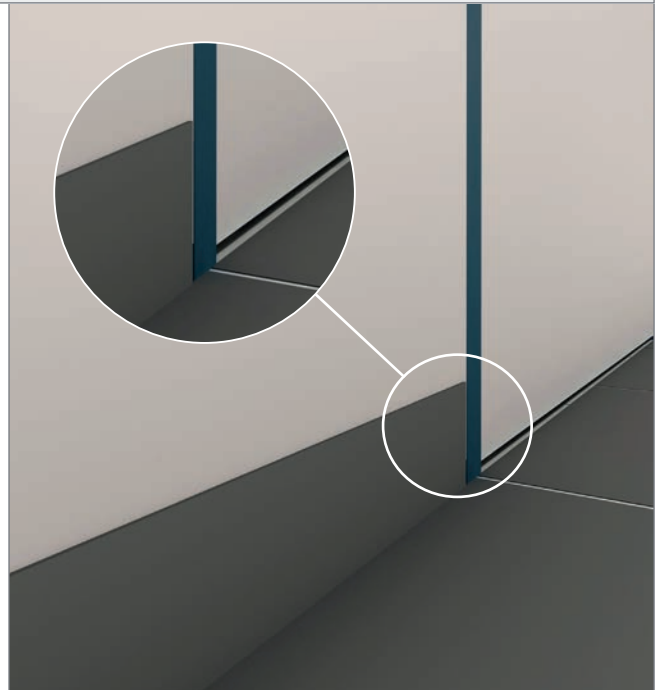

**Flush Planar soffit frame**

If flush frames are used, the skirting can be set into the wall to achieve a completely flush appearance.

# Steel frames for sliding doors

Sliding doors provide tangible benefits. The strongest argument for the use of a sliding door is the significant gain in space, as the space needed for the pivot range of a conventional active leaf door is no longer required: sliding doors are therefore clearly the No. 1.

The product range LineaLine from BOS Best Of Steel offers the right frame for all sliding door variations: sliding door frames for sliding doors running in front of and in the wall, as well as sliding door frames for doors running in the recess. In addition to this, BOS also offers sliding door frames for operating theatre areas.

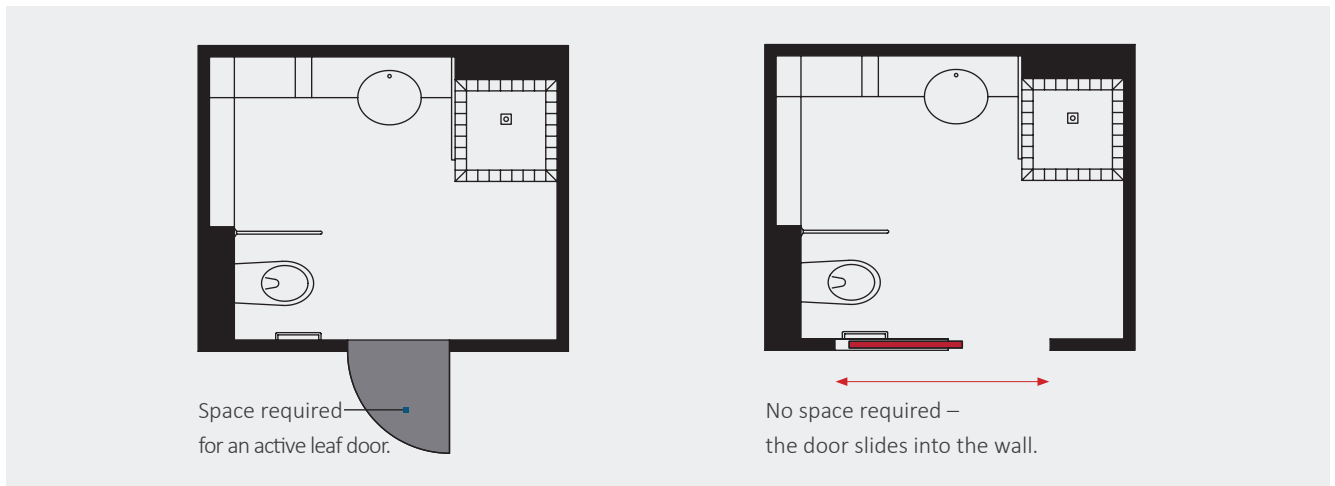

The areas of application for sliding doors are considerable. You can find various well thought-out solutions here, which represent just a selection out of our programme.

LineaOutside for brick walls	26
LineaOutside for stud walls	27
LineaCompact for brick   stud walls	28
LineaSet   LineaSet One for stud walls	29
LineaECON5	30





# Steel frames for sliding doors

All sliding door frames are also available in larger sizes as 1 or 2 leaf designs. They are made of steel or stainless steel and can be optionally given a powder coating finish. The sliding door frames can be combined with any conventional door leaf from a renowned manufacturer.

## Options for manual design:

### Opening style

- 1 and 2 leaf designs
- Synchronised track design
- Linear return

### Fittings

- Hinged cover
- Lead lining
- Potential equalisation
- Sealed closing version
- Opening aid Push-to-close T-Master (Softmaster)
- Closure cushioning Softslide
- Catch stopper

## Options for automatic design:

### Opening style

- 1 and 2 leaf designs
- Synchronised track design

### Operation methods

- Movement sensor
- Surface switch
- Switch in architrave
- Remote control
- Active infra-red light curtain
- Control system for barrier-free WC facilities

### Fittings

- Hinged cover
- Lead lining
- Potential equalisation

### Programming

- Hand terminal

For further options and combinations please contact us.

DIN left  
(closing to the left)

DIN right  
(closing to the right)

# Steel frames for sliding doors LineaOutside for brick walls

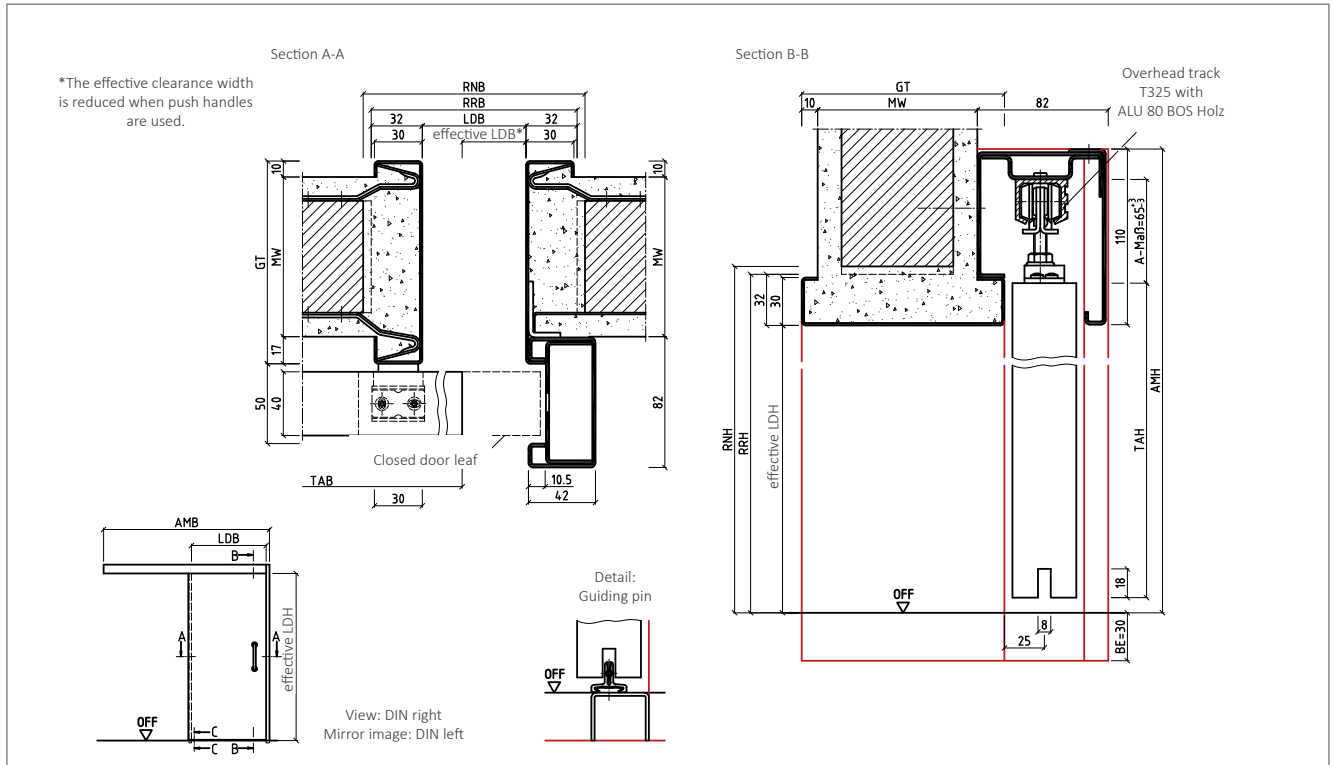

- SvdW  
LineaOutside
- Sliding door frame for doors running in front of the wall (1 part)
  - For brick walls
  - Other measurements and designs possible

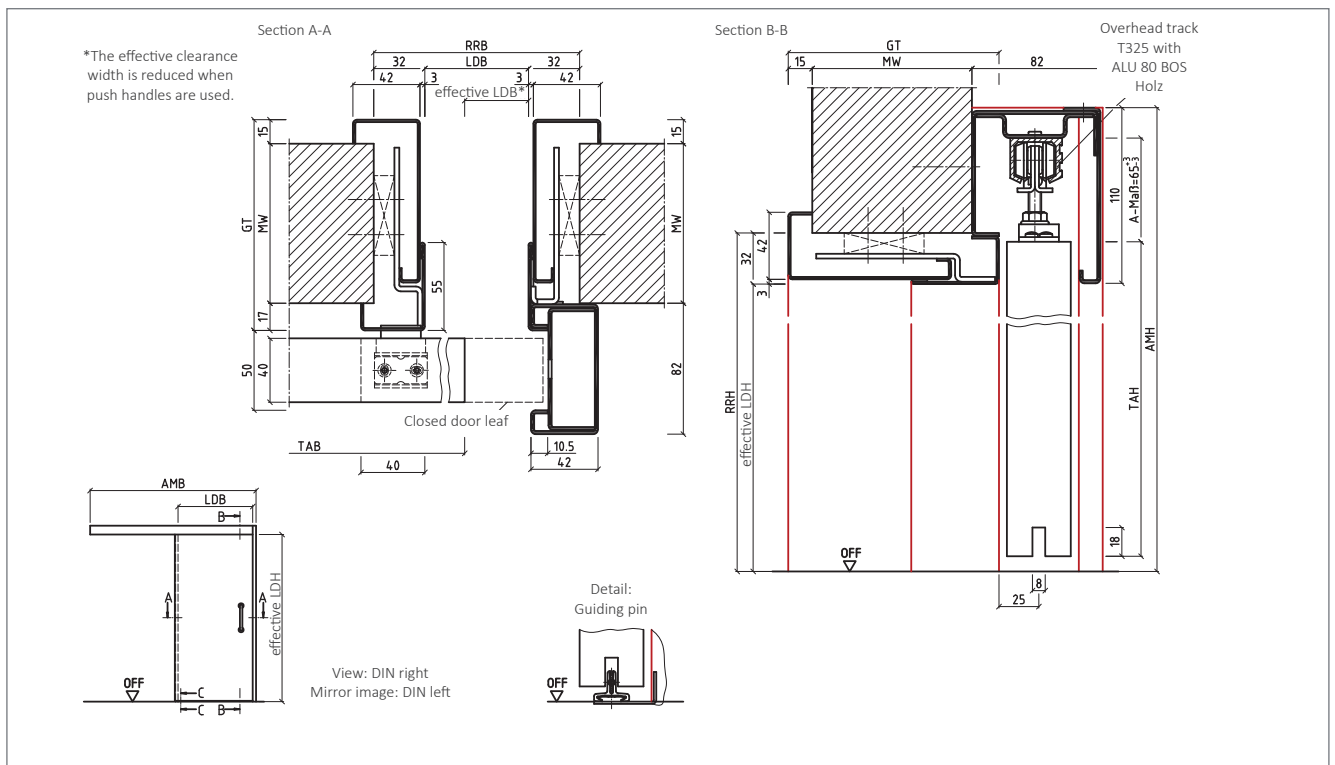

- wSvdW  
LineaOutside
- Sliding door frame for doors running in front of the wall (2 part split) for subsequent installation
  - For brick walls
  - Other measurements and designs possible

# Steel frames for sliding doors

## LineaOutside for stud walls

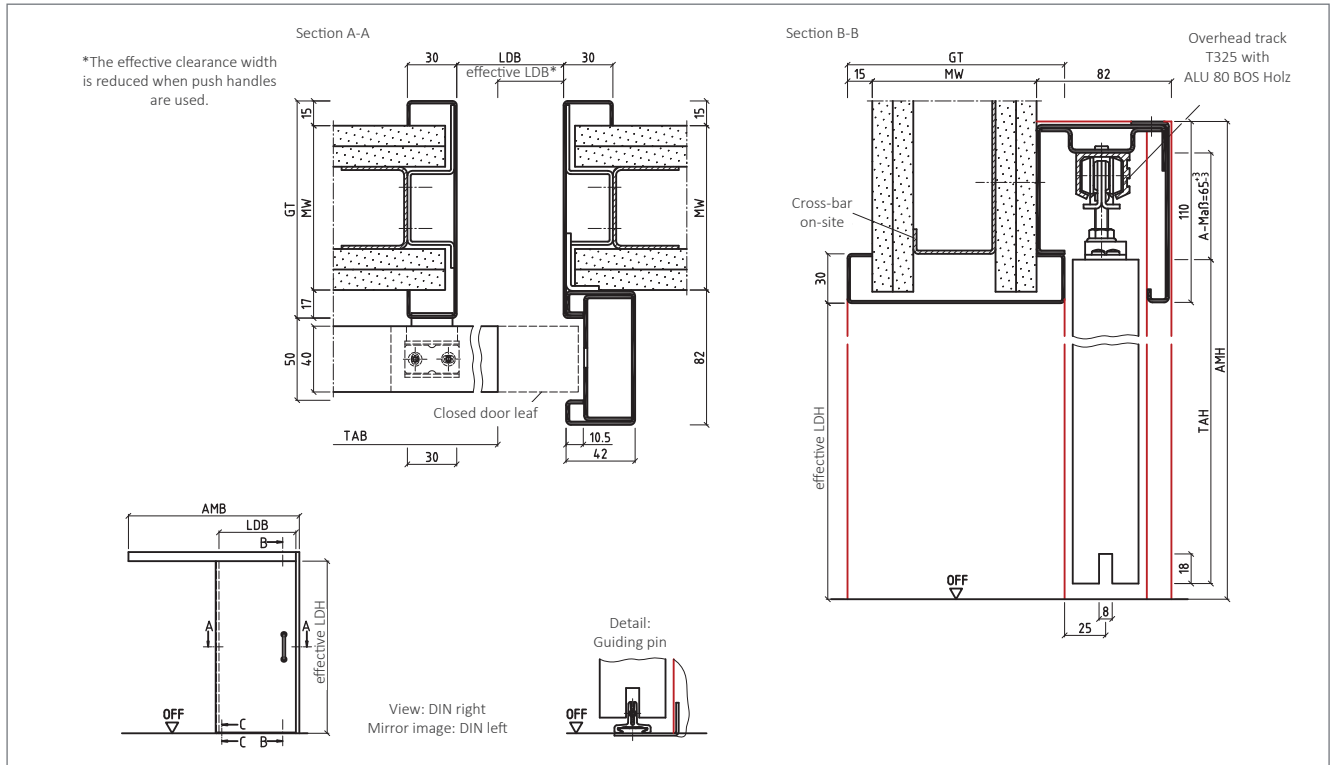

SvdW  
LineaOutside

- Sliding door frame for doors running in front of the wall (1 part) for installation together with the wall
- For stud walls
- Other measurements and designs possible

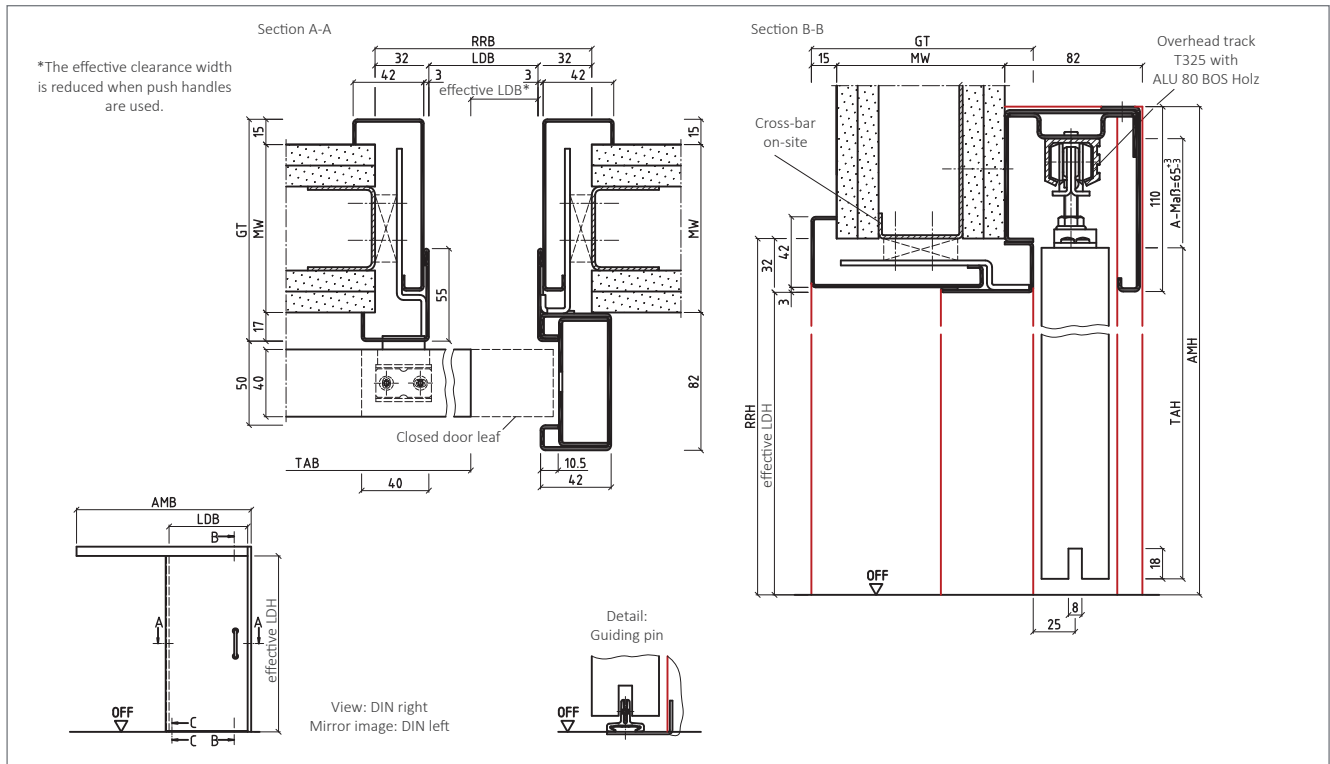

wSvdW  
LineaOutside

- Sliding door frame for doors running in front of the wall (2 part split) for subsequent installation
- For stud walls
- Other measurements and designs possible

# Steel frames for sliding doors LineaCompact for brick | stud walls

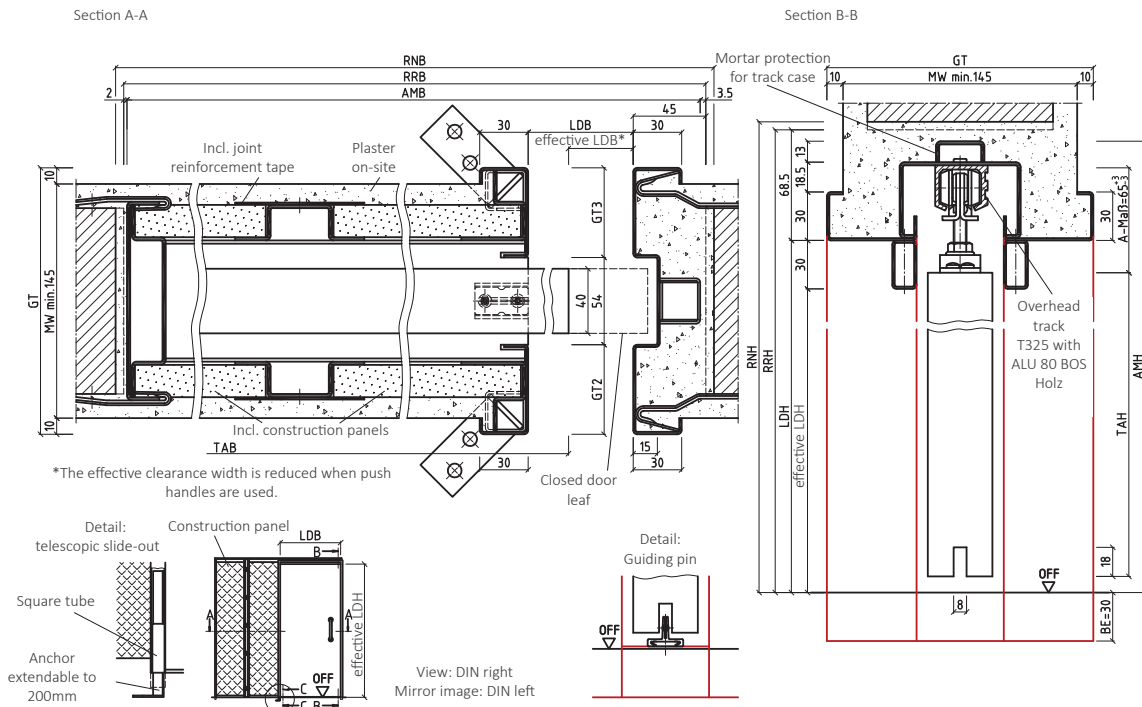

ISidW  
LineaCompact

- Sliding door frame for doors running in the wall (1 part)
- For brick walls
- Other measurements and designs possible

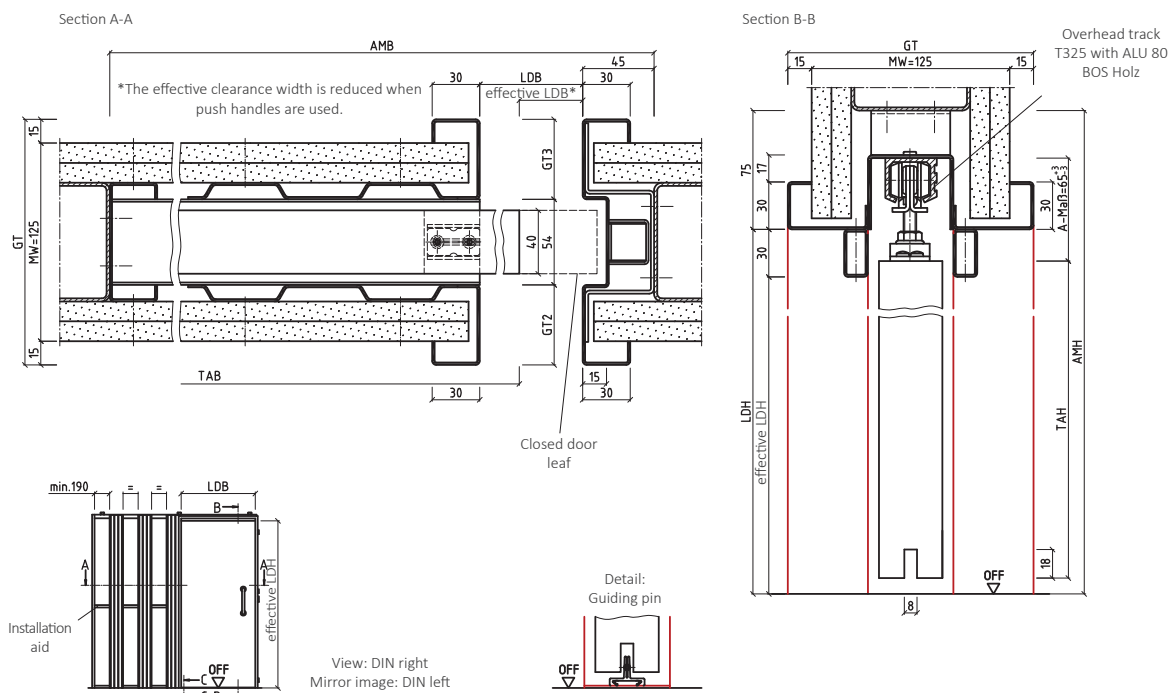

ISidW  
LineaCompact

- Sliding door frame for doors running in the wall (1 part) for installation together with the wall
- For stud walls
- Other measurements and designs possible

# Steel frames for sliding doors

## LineaSet | LineaSet One for stud walls

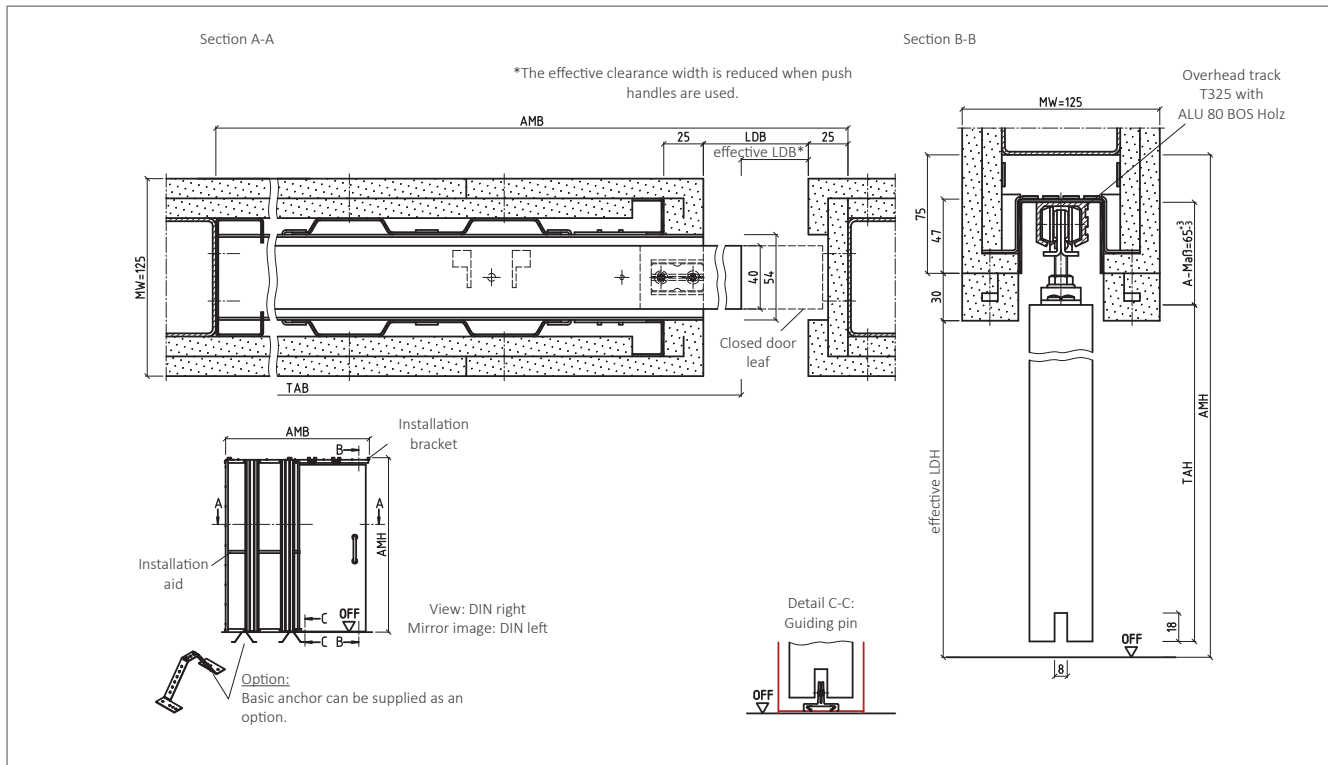

LineaSet /  
LineaSet One

- Sliding door case for doors running in the wall without frame
- For stud walls
- Other measurements possible

**LineaSet** is a dismantled sliding door case for doors running in the wall. It is installed together with the wall and can be used universally in combination with timber, aluminium or steel frames. Alternatively, the passageway can be given a discreet appearance using plasterboard.

**LineaSet One** has an identical design to LineaSet. This sliding door case is pre-assembled as 1 part.

**LineaECON5** is a disassembled cover frame for LineaSet and LineaSet One (see page 30).

LineaSet, LineaSet One and ECON5 are available from stock at short notice.

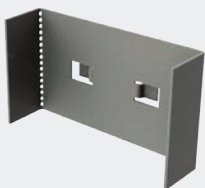

**PlankoFix for 150mm wall thickness (optional)**

For central positioning of the 75mm deep sliding door case on a 100mm UA profile: the PlankoFix is hung in the end profile of the stud wall and then the sliding door case is pushed onto the UA profile. The perforated wings of the PlankoFix are bent 90° and hold the UA profile. The sliding door case is then perfectly positioned for triple panelling on both sides.



**Basic anchor (optional)**

Order at the same time: the cost-effective fastening option to the unfinished floor, which gives the sliding door case the necessary stability and is suitable for installation before the screed is laid.

Can be used from a distance to unfinished floor of min. 20mm to max. 150mm.  
Adjustment area: max. 130mm



**Telescopic anchor (optional)**

For increased stability of the sliding door case, we recommend telescopic anchors, which are fastened to the unfinished floor and are ideally suitable for installation before the screed is laid.

Can be used from a distance to unfinished floor of min. 105mm to max. 175mm.  
Adjustment area: max. 70mm



**Steel removable inspection cover (pair)**

In contrast to a usual plaster panel, the use of the steel inspection cover means the installation and removal of the door leaf is possible without damaging the wall. This simplifies the conversion and retrofitting of the overhead track considerably.

Galvanised and primed, no damping possible with use of ALU 80 BOS.

# Steel frames for sliding doors

## LineaECON5 for LineaSet and LineaSet One

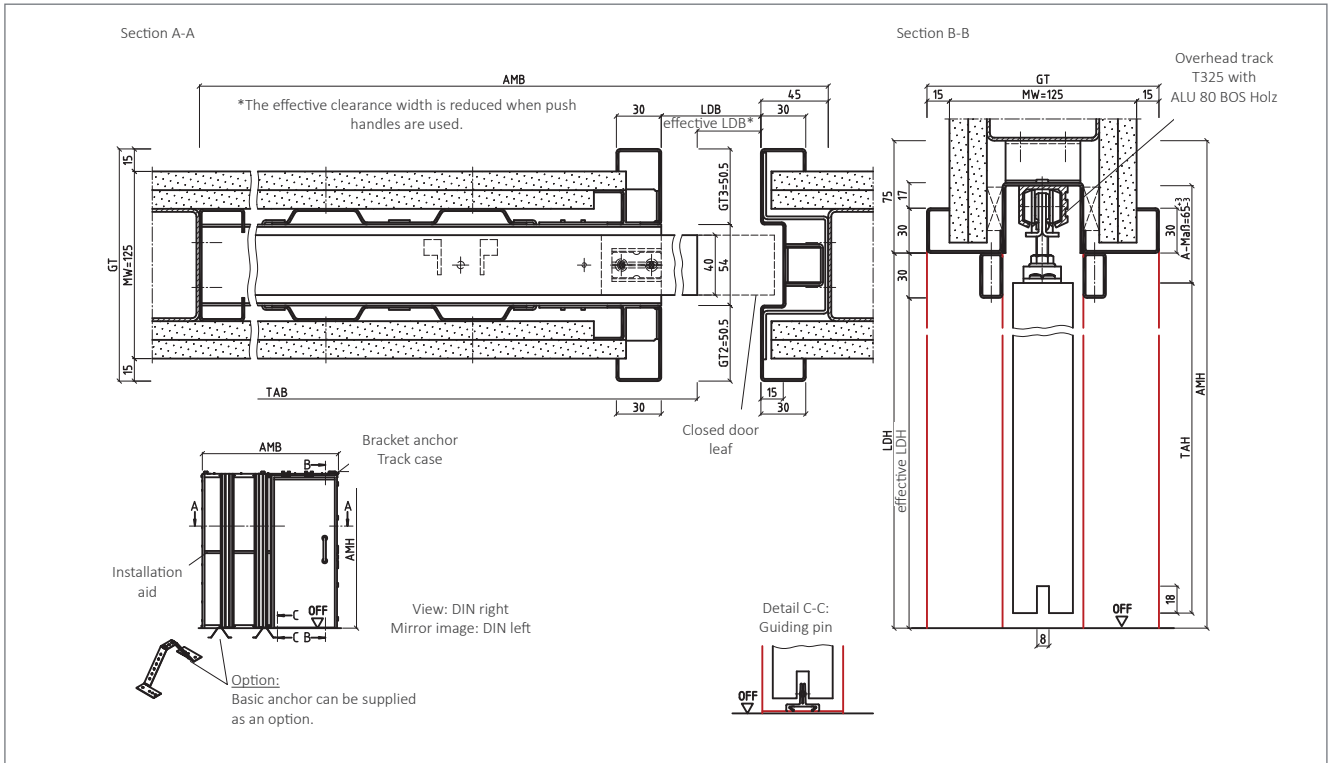

### LineaECON5

- disassembled cover frame for LineaSet and LineaSet One
- available in 3 sizes from stock (860/985/1110 x 2110 mm)
- including removable inspection strip for retrofitting the door leaf



# Steel frame measuring aid for active leaf doors



Also available online.

Enquiry  Call for tender and order

Date: \_\_\_\_\_

Shipping address: \_\_\_\_\_

Person of contact: \_\_\_\_\_

Commission: \_\_\_\_\_

Order no.: \_\_\_\_\_

Requested date: \_\_\_\_\_

**Material strength:**  1.5mm  2.0mm

**Surface:**  galvanized primed  \_\_\_\_\_

**Profile:** \_\_\_\_\_  subsequent installation

Front architrave width:  30mm  \_\_\_\_\_ mm

Front backbend:  10mm  15mm  \_\_\_\_\_ mm

Front shadow groove:  10mm  15mm  \_\_\_\_\_ mm

Total wall thickness: \_\_\_\_\_ mm

Back shadow groove:  10mm  15mm  \_\_\_\_\_ mm

Back backbend:  10mm  15mm  \_\_\_\_\_ mm

Back architrave width:  30mm  45mm  \_\_\_\_\_ mm

**Type of wall:**  brick wall  stud wall  \_\_\_\_\_

**DIN direction:**  DIN left  DIN right  double leaf

**Hinge pockets:**

Quantity:  2 pieces  \_\_\_\_\_ pieces

Type:  BTV 8618  BTV 8618 (S)  \_\_\_\_\_  BTV 10200  BVX 11000

**Distance between hinges:**  3rd hinge, distance between hinges below BBL 1:

Standard acc. to DIN 18101  250mm  \_\_\_\_\_ mm  350mm

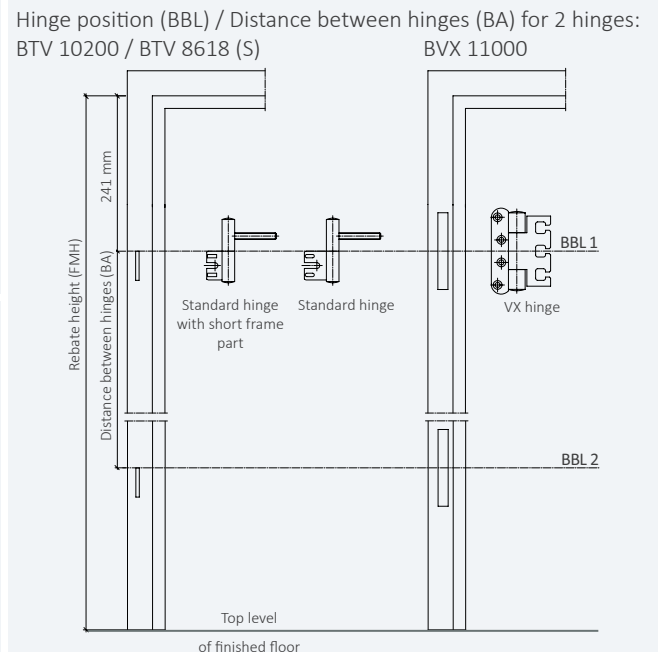

**Nominal wall opening width:** \_\_\_\_\_ mm      **Nominal wall opening height:** \_\_\_\_\_ mm

**Rebate width:** \_\_\_\_\_ mm      **Rebate height:** \_\_\_\_\_ mm

**Handle height:**

1050mm  850mm  \_\_\_\_\_ mm

**Foundation bedding:**

30mm  without  \_\_\_\_\_ mm

**Rebate design:**

**Rebated**

Rebate depth  28.5mm  \_\_\_\_\_ mm

Double rebate

Rebate depth 2  25mm  \_\_\_\_\_ mm

Closing level  4.5mm  \_\_\_\_\_ mm

**Flush**

Rebate depth  46.5mm  \_\_\_\_\_ mm

Double rebate

Rebate depth 2  25mm  \_\_\_\_\_ mm

Closing level  17mm  \_\_\_\_\_ mm

Other notes: \_\_\_\_\_

# Speciality is our standard

You can rely on top quality and the best service: With over 450 employees, BOS Best Of Steel is the market leader in Germany in the field of steel frames and is also one of the leading manufacturers in many other European countries. We offer our customers special, non-standard and standard frames of the highest quality as well as outstanding advisory, delivery and after-sales service – supported by our BOS Architect Consulting team.

Our products have been honoured repeatedly, amongst other with the Red Dot, the Iconic, the German Design, the Universal Design and the Plus X awards.

## Architect Consulting Service

### We are here for you!

The friendly BOS Architect Consulting Service team can be reached at:

Phone: +49 (0) 2572 203-204

Fax: +49 (0) 2572 203-209

or send us an E-Mail: [architekten@BestOfSteel.de](mailto:architekten@BestOfSteel.de)

Monday to Thursday | 8am to 5pm

Friday | 8am to 3pm

### We can offer you:

- Concept solutions for your project
- Complete system solutions for door elements
- Individual solutions for your requirements
- CAD drawings
- BIM models (Revit families)

We can advise you on the telephone, personally at our Technical Centre or at your location.

### BOS GmbH Best Of Steel

Lütkenfelde 4

D-48282 Emsdetten

Tel.: +49 (0) 2572 203-0

Fax: +49 (0) 2572 203-109

E-Mail: [info@BestOfSteel.de](mailto:info@BestOfSteel.de)

[www.BestOfSteel.de](http://www.BestOfSteel.de)



BOS Best Of Steel is proud to be part of the JELD-WEN global family of product brands and companies.