

Duo 15Z with loop hinges and direct wall connection

This document provides guidance on the fitting of a steel door frame intended for use with a standard non-fire, non-acoustic or glass door. In the case of a specialist door being used, any special preparation required for the installation of the frame must be gained from the door producer or certifier.

Included in scope of delivery:

- 2 part split frame Duo 15Z
- 5.2 m elastic hollow chamber seal (separate)
- Levelling anchors (mounted)

To be supplied by the customer:

- Drilling screws for stud walls
- Screws with dowels or frame dowels for brick walls
- Fixings must be the appropriate length and type for the structural wall medium

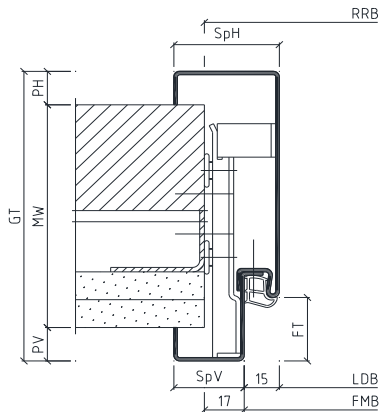

FMB	=	Frame rebate width
FT	=	Rebate depth
GT	=	Total profile depth
LDB	=	Clearance width
MW	=	Receiving opening
OFF	=	Finished floor level
PH	=	Back backband
PV	=	Front backband
RRB	=	Structural wall opening width
SpH	=	Back architrave
SpV	=	Front architrave

15Z for brick / stud walls

Please note: Read the installation instructions carefully before starting.

Installation should be carried out by suitably trained personnel!

Before installation:

- Check that the frame conforms to the planning specifications of the client.
- Check the angularity of the frame.

- (1) Front part of frame
- (2) Back part of frame
- (3) Drilling screw
- (4) Levelling anchor
- (5) Guiding anchor
- (6) Levelling screws (2 per anchor)
- (7) Drilling screws for stud walls, screws with dowels for brick walls (2 per anchor)
- (8) Wall/Supporting structure
- (9) Elastic hollow chamber seal

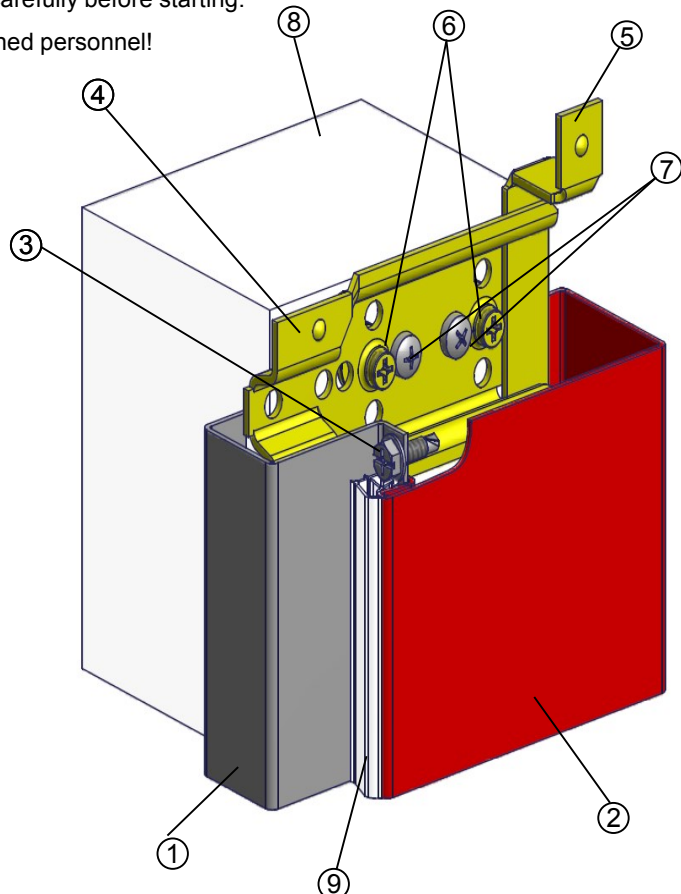

These installation instructions do not include static information.

Best Of Steel | 1

Seals

Do not use nitro-based paint. Cut the seal for the headpiece to length without stretching and without a mitre. Then push the seal into the correct position in the profile. Repeat for the side parts.

Spacer rails

Spacer rails are transportation and installation aids, which are fastened at the bottom of the steel frame to the side parts. The spacer rails can be used as an installation aid in primed frames and should be removed afterwards. The spacer rails in powder coated frames must be removed before installation.

Spacer rail in a primed frame

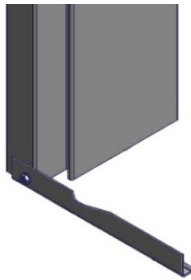

Spacer rail in a powder coated frame

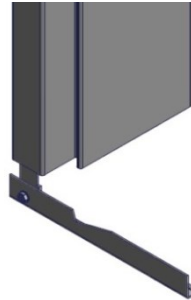

Please note:

The profile forms and measurements can differ from those illustrated in the installation instructions. Further installation tips can be found in the TTZ installation guidelines at www.BestOfSteel.de.

If the frames are used in combination with fire or sound protection door leaves, the mounting parts and installation instructions from the authorisation holder must be followed!

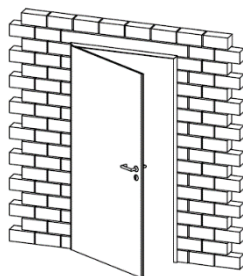

View DIN left



View DIN right

Detail metre mark:

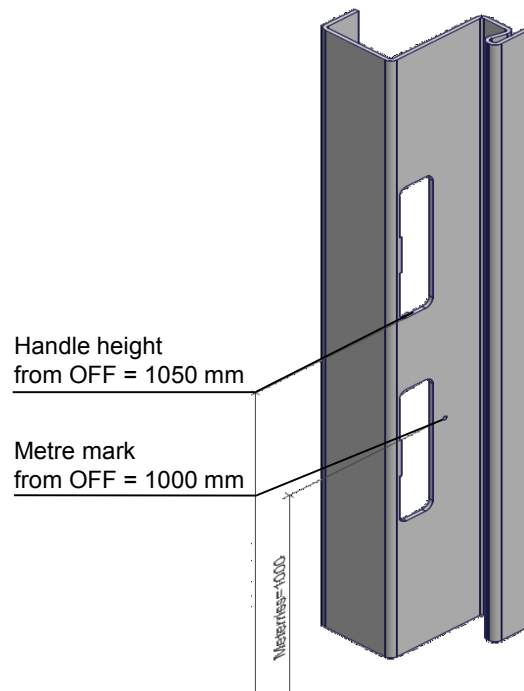

1. The frame is delivered pre-assembled. Remove the drilling screws (3) connecting the front (1) and back part (2) of the frame using a cross tip screwdriver and pull the two frame parts apart.

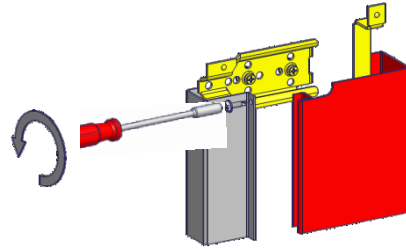

2. Insert the front part of the frame (1) into the wall opening and align according to the metre mark (see page 2 for further information about the metre mark).
If necessary, enlarge the opening for the mortar protection case and the hinge pockets.

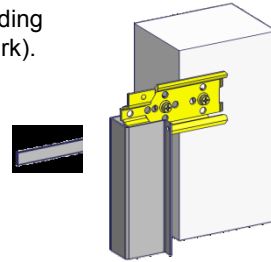

3. Align the front part of the frame (1) using the levelling screws in the centre. Check the perpendicular and horizontal alignment using a spirit level.

Important: At least two threads of the levelling screws (6) must grip the anchor (4).

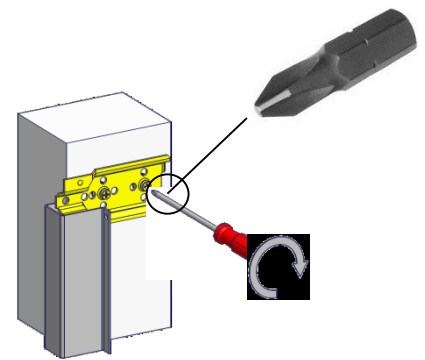

Please ensure the surrounding structure is of a sufficient strength to carry the weight of the doorset and provide a firm fixing for the screws.

4a. Stud walls:

Join the aligned front part of the frame (1) to the stud wall support by inserting the drilling screws (7) through the holes provided in the levelling anchor (4) (two screws per anchor).

4b. Brick walls:

If the Duo 15Z is to be installed in brick walls, insert and align the front part of the frame (1). Then mark the position for drilling the holes to attach the frame to the wall. Remove the frame front part (1), drill the holes where marked and insert the dowels. Finally, reinsert the front part of the frame (1) in the wall opening and fasten.

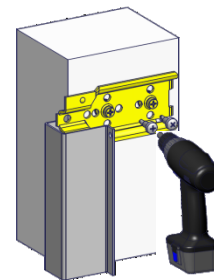

- When installing the hinges, follow the manufacturers' instructions. The hinge pockets of the frame are supported and reinforced via the connection to the wall. Therefore, it is vital that the wall connection is carefully aligned so that the overall perpendicular and horizontal alignment is correct. Once the frame is correctly positioned, please line and secure the hinge reinforcement plate to the wall structure. Refer to the door manufacturer for guidance on the correct padding material. Please make use of all screw holes, so that the plate is securely fastened to the wall.

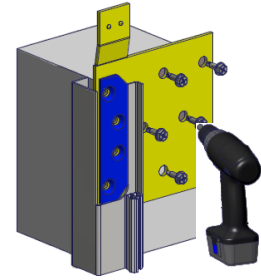

- Place the frame back part (2) carefully into position, making sure that the levelling anchor (4) engages with the guiding anchor (5). Connect the two frame parts in the rebate with drilling screws (3). Tightening torque max. 4 Nm. Remove the spacer rails if still present.

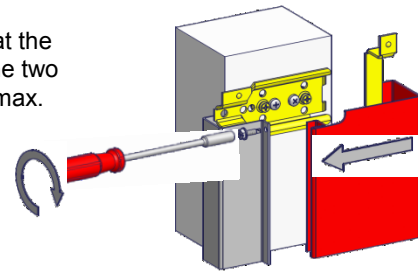

- Primed frames should now be painted. Once the paint is dry, insert the elastic hollow chamber seal (9), thus covering the drilling screws (3) in the rebate.

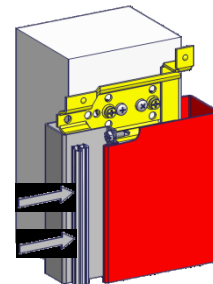

Maintenance Instructions

In order to ensure a proper functioning of the frame, a regular inspection and rectification of any defects identified is recommended.

General condition: Please check the frame and the door leaf for any mechanical or corrosion damage. These types of damage must be rectified!

Seals

These are to be checked for damage, a proper fit and wear. Damaged seals should be replaced. Dirt on the seals can be removed using commercial detergent.

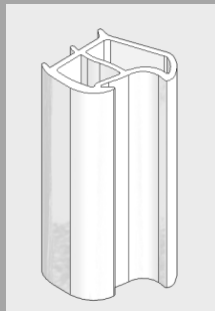

Elastic hollow chamber seal

Hinge pockets

Please control the fastening of the hinges and tighten the screws if necessary. Replace worn parts.

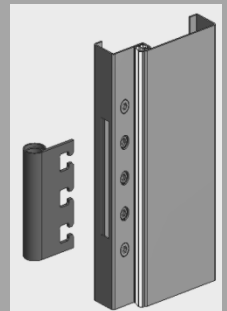

VX hinge pocket with 3 clamping screws and 2 adjustment screws

Latch/Bolt cut-out

Please check the area of the latch/bolt cut-out for defects. Any damages should be correctly repaired.

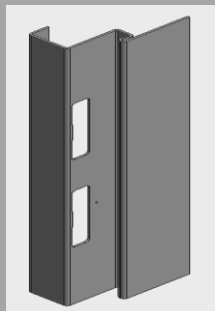

Latch/Bolt cut-out

Attachments

Please check the fastenings of all attachment parts (striking plates, door closers etc.) and tighten the screws where necessary. Damaged parts should be replaced.

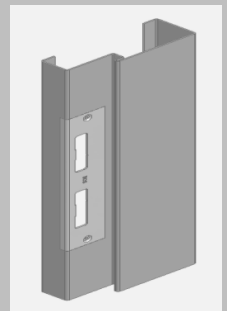

Striking plate

Stainless steel frames

For the care of stainless steel frames please refer to our instructions:

<https://www.bestofsteel.de/en/tools-downloads/care-and-maintenance-instructions/>